

FLUKE®

Reliability

VIBGUARD®

IIoT

Commissioning



This manual is only intended for use with GL-certified VIBGUARD CMS on wind turbines.

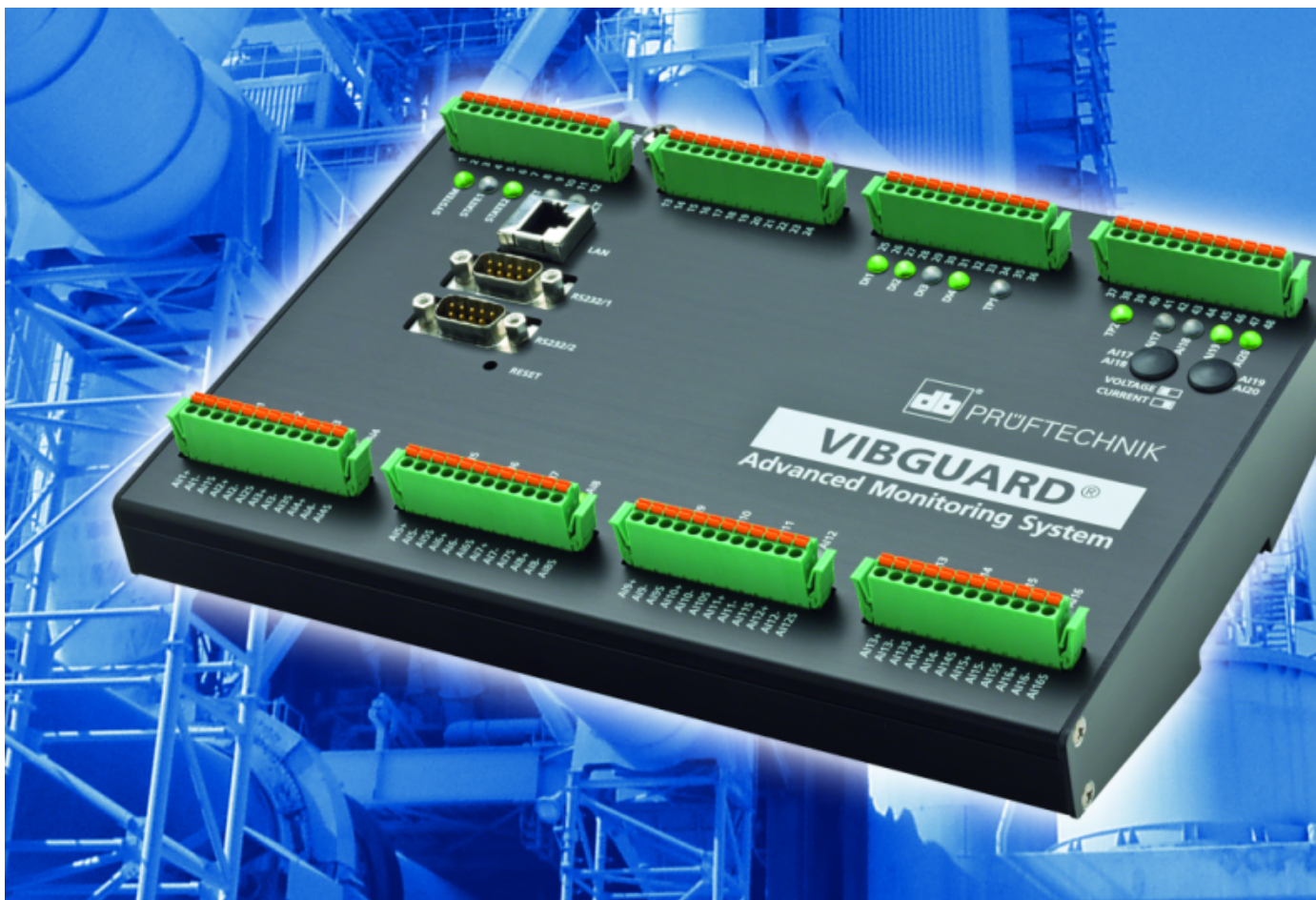

db PRÜFTECHNIK

Edition: 01.10.2018
Doc. no.: LIT 78.221.EN
Translation of the German manual

Type: VIB 7.800, VIB 7.810, VIB 7.811, VIB 7.815, VIB 7.820, VIB 7.825
Serial number and year of manufacture: see type plate
PRODUCER: Fluke Deutschland GmbH, Freisinger Str. 34, 85737 Ismaning, Germany, + 49 89 99616-0, www.pruftechnik.com

LEGAL NOTES

Protection notice

These instructions and the product described herein are protected by copyright. The authors reserve all rights. These instructions must not be copied, reproduced translated or made available to third parties in any other form - in part or in full - without prior approval.

Exclusion of liability

Any claims against the authors in relation to the product described in these instructions are excluded. The authors do not provide any guarantee for the accuracy of the contents of these instructions. Furthermore, the authors are not in any way liable for any direct or indirect loss arising from using the product or from using these instructions even if the authors have identified the potential for such a loss.

The authors do not accept any liability for potential faults in the product. This exclusion of liability also applies to dealers and distributors. Subject to errors and design changes, in particular in terms of further technical developments.

Trademark

The trademarks and registered trademarks referenced in these instructions are generally marked as such and are the property of their owners. The absence of a marking does not however mean that names are not protected.

VIBGUARD is a registered trademark of PRÜFTECHNIK AG.

© **Fluke Corporation. All rights reserved.**

Fluke Deutschland GmbH
Freisinger Str. 34
85737 Ismaning, Germany
+ 49 89 99616-0
www.pruftechnik.com

Contents

1 Prior to starting	5
1.1 Notes regarding these instructions	5
1.2 Markup	5
1.3 Abbreviations	5
1.4 Service addresses	5
2 Safety	6
2.1 EU conformity	6
2.2 Intended use	6
2.3 Safety markings	7
2.4 Type plates	8
2.5 Information for the operator	9
2.6 Information for operating personnel	10
2.7 Residual hazards and protective measures	11
3 Preliminary remark	12
3.1 Notebook system requirements	12
3.2 Additional components	12
4 Visual inspection	13
4.1 RPM sensor function test	13
4.2 Cable routes and wiring	13
5 Connection test	14
5.1 Switching on VIBGUARD IIoT	14
5.2 Establishing a connection	14
5.3 Testing the connection	14
6 Network configuration	16
7 Sensor configuration	17
8 Sensor test	19
8.1 Sensor position	20

9 Process signals	21
10 Configuring Email transmission	22
10.1 Configuration	22
11 Sending a test email	26

1 Prior to starting

1.1 Notes regarding these instructions

These instructions are a part of the product. As such, they must be kept throughout the product service life. These instructions must be handed over to any subsequent owner or user of the product.

1.2 Markup

Texts are marked as follows in these instructions:

- **Action steps** are indented and marked with a • bullet point.
- **List entries** are indented and marked with a dash -.
- **Functional elements** on the user interface, such as buttons, commands, links: <Element> in angle brackets.
- **Labels** on the user interface, such as window titles, field names: "Designation" in quotation marks.



Supplementary information / tips: Functional notes are introduced with a context-dependent keyword.



Safety notes: Warnings are introduced with the keyword **CAUTION** if there is a danger of **personal injury**. Failure to observe these warnings may result in minor or moderate injury.

If there is a danger of damage to **property**, warning notices are introduced with the keyword **Note**.

1.3 Abbreviations

The following designations are considered equivalent in these instructions:

- Condition Monitoring System = CMS
- VIBGUARD IIoT Condition Monitoring System = VIBGUARD IIoT or System
- VIBGUARD IIoT system module = system module
- Sensors, cables, mountingadapters = measuring equipment.
- VIB 7.800, VIB 7.810, VIB 7.811, VIB 7.815, VIB 7.820, VIB 7.825 = VIB 7.8xx
- Current Linedrive = CLD

1.4 Service addresses

Hotline	+49 89 99616-0 Please have the serial number of your system module ready when contacting our hotline ("Type plates" on page 8).
Shipping address	Fluke Deutschland GmbH, Freisinger Str. 34, 85737 Ismaning, Germany

2 Safety

VIBGUARD IIoT was designed and built following careful selection of the harmonized norms to be complied with as well as other technical specifications. The system therefore corresponds to the state of the art and ensures the highest degree of safety.

Nevertheless, there are still risks relating to installation, commissioning and operation which are to be avoided.

Observe the general safety instructions in this section as well as the warnings in the instructions. Safety instructions and warnings explain how you should act in order to protect yourself, others and objects from harm.

2.1 EU conformity

PRUFTECHNIK hereby declares that VIBGUARD IIoT conforms to the relevant European directives. The complete text of the EU conformity declaration is available at the following Internet address:

:

- <https://www.pruftechnik.com/com/About-us/Company/Certificates-and-Material-Safety/>



2.2 Intended use

VIBGUARD IIoT is a stationary condition monitoring system for monitoring the condition of machines mounted on anti-friction bearings. The system records and processes the following signals and parameters:

- Vibration parameters, broadband and narrow-band
- Time signals
- Spectra
- Temperature
- Process parameters

The system works continuously and records the machine signals synchronously on all channels¹. It is therefore suitable for machines with dynamic operational behavior for which the operating and process parameters need to be recorded simultaneously and at short intervals.

The system may only be operated within the specifications given in these instructions. PRUFTECHNIK shall not be liable for any damage caused by misuse.

¹maximum number of channels is type-specific

2.3 Safety markings

Please refer to the following figure for the safety markings on the VIBGUARD IIoT. The safety markings must be observed and must not be concealed or removed. For the variants that are installed in a control cabinet (VIB 7.xxx-PS), the safety labels must be attached at a suitable point in the control cabinet.

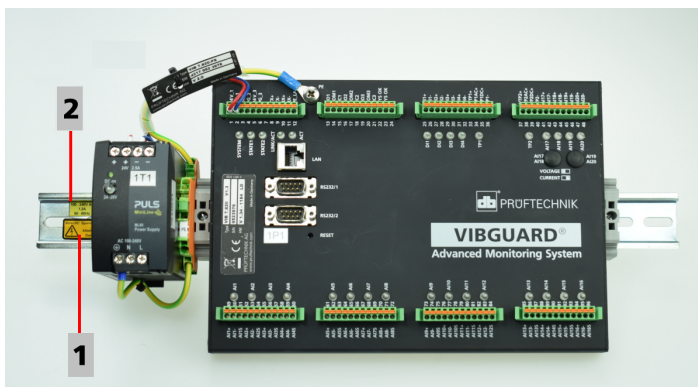
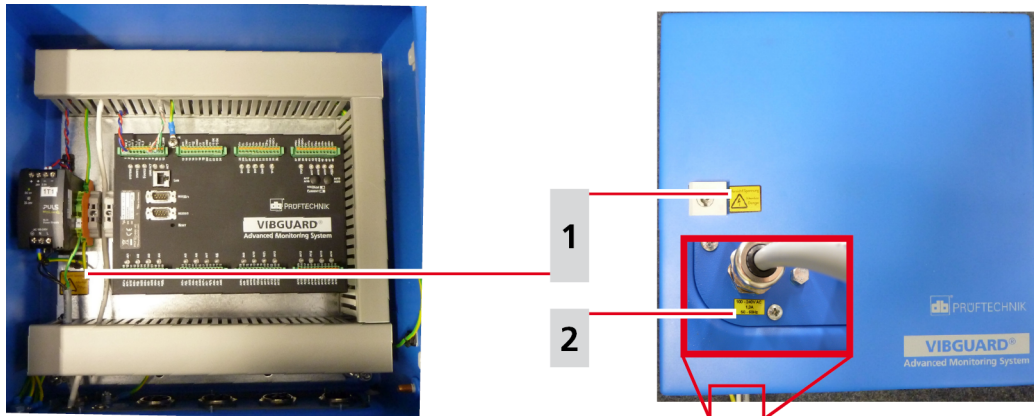

1	Vorsicht! Spannung Attention Danger	
VIB 7.8xx-SDH	A yellow sticker each on the housing lock and below the power supply.	
VIB 7.8xx-PS	A yellow sticker on the top hat rail.	

2	100 - 240V AC / 1,3 A / 50-60 Hz	
VIB 7.8xx-SDH	A yellow sticker on the outside of the cable gland for the mains supply.	
VIB 7.8xx-PS	A yellow sticker on the top hat rail.	

2.4 Type plates

System module

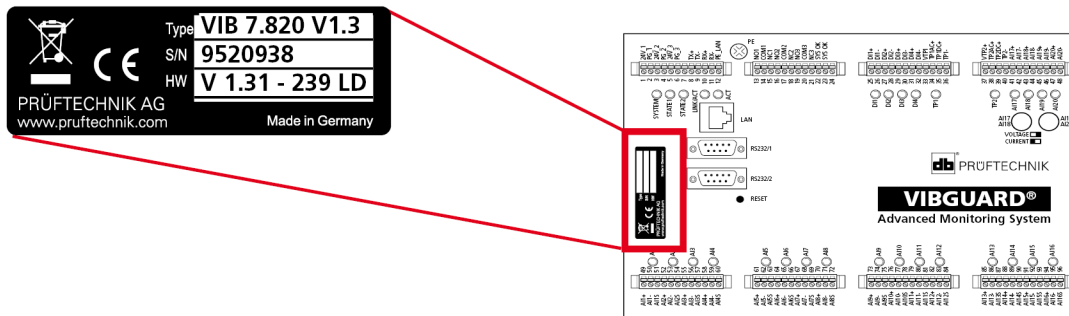

The type plate on the **system module** contains the following information:

- **Type:** Item number (VIB 7.820), hardware status (V1.3) of the System module.
- **S/N:** Serial number of the system module, 7 digits, starting with 95..
- **HW:** Status (V 1.31), number (239), variant (LD = LineDrive) of the built-in board.

Protective housing

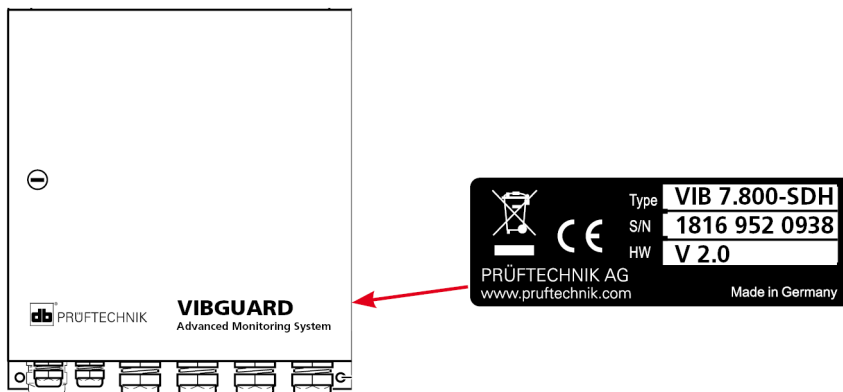

The type plate on the **protective housing**, or on the **power supply** cabling contains the following information about the entire system:

- **Type:** VIB 7.8xx-SDH or VIB 7.8xx-PS - Item number of the entire system.
- **S/N:** Production week (WWYY) of the entire system and serial number of the system module installed.
- **HW:** Hardware status of the protective housing (e.g. V 2.0).

2.5 Information for the operator

Obligations of the operator

Maximum safety can only be achieved in practice if all measures required for this are adopted. As the operator, it is part of your duty of care to plan these measures and monitor their implementation.

Ensure that the following requirements are met:

- Qualified specialist personnel for installation, commissioning and operation is available.
- Installation material and tools are provided.
- Voltage supply and network connection are present in accordance with the specification.
- Potential equalization is provided

Integration of the system into existing equipment

The safety of a plant in which the system is integrated is the responsibility of the installer of the plant.



CAUTION! Except for the mains power supply to the system, all other connected circuits must be SELV circuits.

Ensure that the following requirements are noted:

- Use the system in accordance with the intended use.
- Only operate the system in a technically flawless state.
- Only use original accessories and original spare parts.
- Observe all nationally applicable regulations, all safety, accident prevention and environmental protection regulations as well as all recognized technical rules for safe and proper work.

Training

Provide ongoing training for operating personnel in relation to the application of all safety regulations in safety instructions. Ensure that the following requirements are complied with:

The applicable legal and otherwise binding safety and accident prevention regulations as well as the general safety instructions and warnings must be adhered to and followed.

Ensure that operating personnel work in a safety-conscious manner.

2.6 Information for operating personnel

Operating personnel qualifications

Installation and disassembly may only be performed by a qualified specialist electrician.

Commissioning and operation must only be performed by personnel who have been trained and authorized to do so.

Personal protective equipment

No protective equipment is required for installation, commissioning, normal operation and disassembly of the system.

Regulations for normal operation

The operating state of the system module is displayed via the SYSTEM LED. The LED lights up orange while the system module is starting up and changes to green (normal operation).

- Check the following points at regular intervals:
 - Is there any identifiable damage on the system components and on the measuring equipment?
 - Are the cables crushed or damaged?
- Rectify any defects detected immediately or report them to the operator. The system and measuring equipment must only be operated in a flawless state!
- In the event of functional faults, disconnect the system from the supply and secure it against a restart.

Operation of a machine is not impaired if the system is out of service. The machine can therefore remain in operation.

2.7 Residual hazards and protective measures

VIBGUARD IIoT is verifiably safe assuming it is used as intended. The following damage may occur if operated incorrectly or used improperly:

- Personal damage
- Damage to the system or to the machine

Danger due to running machine!

During installation and maintenance work on the machine, there is a risk of injury from moving machine components.

- Shut down the entire machine system and secure it against unintentional restarting.

Danger due to electric shock!

There is a risk of injury due to low voltage when working on the switch cabinet when it is open (230 V).

- Observe the safety markings on live components.
- Before carrying out any installation, repair or maintenance work, disconnect the system from the power supply, determine that there is no voltage and secure the power supply against being switched on again.
- Do not open, repair or modify with power supply VIB 5.965-2.5.

Danger due to improperly laid cables

Personnel may stumble over an improperly laid cable and injure themselves. The cable can be damaged due to external influences.

- Lay the cable in such a way that no one can stumble over it.
- Use cable ties or a Velcro fastener to fix the cable in place.
- Lay the cable in a cable duct or protective tube.

Damage due to electrostatic discharge

During installation, repair and maintenance work on the system, the electronic components can be damaged if touched due to electrostatic discharge.

- Use an earthing strap if contact with the components cannot be ruled out.

Damage due to contamination

In a loaded industrial environment, the system components may have their function impaired or be damaged due to contamination or moisture when the switch cabinet is open.

- Keep the switch cabinet closed as much as possible.

Incorrect measurements due to electromagnetic interference

High frequency rays or electrostatic discharge in the vicinity of the system and measuring equipment can lead to incorrect measurements.

- Do not lay the sensor cables in the vicinity of heavy current lines.
- Select an installation site with low electromagnetic radiation exposure.

3 Preliminary remark

This manual requires that you work with a common browser, e.g. Firefox (Mozilla) or Firefox Portable V15.x.x or higher. Firefox Portable can be found on your installation CD.

With regard to the computer platform, this manual assumes that you are working with a PC running Windows 7. The interfaces of the various operating systems differ from each other. This means that installation on other systems may be slightly different.

You should be familiar with Windows Explorer to the extent that you are able to copy files and start programs in the course of installing the software.

3.1 Notebook system requirements

- Operating system: min. 32 Bit Windows 7 Prof / Windows XP Prof (SP3)
- Processor: Dual Core 2.4 GHz or equivalent processor
- Memory (RAM): at least 3 GB (of which at least 1.5 GB is free for the application)
- Hard disk: 5 GB free
- Ethernet interface (address can be adjusted)
- CD-ROM drive: for program installation
- Display: Color monitor (1280 x 800) or better
- Mouse/trackpoint/touchpad: required
- Interface: one serial RS232 port (via USB adapter if necessary)

3.2 Additional components

DuringStartupthe following are also required as a general rule:

- 1 hub for connecting the CMS to the notebook
- RJ 45 patch cable for network connection of devices; length at least 1 m
- Installation CD: only required if none of the browsers described above are available!
- Insert the installation CD in your CD-ROM drive.
- Start the **FirefoxPortable_15.0.1_German.paf.exe** file from the root directory of the CD. The requisite software is now unpacked to the specified target directory.

4 Visual inspection

EveryStartup begins with a visual inspection of the sensors that are installed. In this regard, it is necessary to check that the accelerometers are firmly screwed in, the cables are undamaged, and the RPM sensor is correctly aligned with the trigger mark.



Damaged parts are to be replaced with original spare parts immediately.

4.1 RPM sensor function test

- Slowly turn the trigger mark past the RPM sensor.

Whenever the trigger mark is detected by the sensor, the LED on the sensor lights up. Plugs which also contain an operating display can be supplied. In this regard, the additional LED lights up continuously if the power supply is correct.



CAUTION! Danger of property damage!

Check the distance between the installed sensor and the trigger mark. The permissible range is **2.3 to 8 mm**.

If the distance is too small, the sensor and trigger mark may come in contact with each other and be damaged during operation. If the distance is too great, the sensor is not able to detect a trigger signal.

4.2 Cable routes and wiring

- By means of a visual inspection, check that the cables from the sensors to the system module are properly laid and undamaged.
- Check the terminal wiring in the system module. To this end, carefully pull on each individual cable and also check whether individual terminals have loosened.
- Check that the cable loops are properly laid.
- Check that the cables in the protective housing have not got caught or been damaged when closing.

5 Connection test

5.1 Switching on VIBGUARD IIoT

- Switch on the power supply for the CMS.
- The system module starts up and launches the measuring configuration that is currently loaded on the system.
- Check the LED status on the system module.

The system is operational if the system LED lights up green. Observe the LEDs on the analog channels for fault messages ("LED displays on the system module" on page 1).

5.2 Establishing a connection

The connection between VIBGUARD IIoT and the notebook is established via the network connection.

The network cable on the VIBGUARD IIoT is not suitable for a direct connection between the notebook and VIBGUARD IIoT as it is wired one to one. A direct connection is only possible with a crossed patch cable (**Cross cable**).

We recommend using a hub that may be available in the system or using a **hub** that you have with you. In such cases, the standard cabling of the CMS can be retained and the notebook can be connected to the hub using a standard network cable.

If the network is set up on the system module with **single wires** (terminals 8-12), the **LAN socket** must not be used. If necessary, disconnect the single-wire connection before connecting the notebook to the LAN socket using a crossed network cable.

5.3 Testing the connection



The initial connection to the VIBGUARD IIoT is established via the IP address assigned at the factory.

This information and other parameters for startup are included in the scope of delivery as a paper printout.

During startup, the standard IP address is to be changed and adapted to the network on-site ("Network configuration" on page 16).

	Standard network configuration
IP address	192.168.1.180
Subnet mask	255.255.255.0
Gateway	192.168.1.13
Username, level 3	user3
Password, level 3	user3

- Establish a connection to the CMS.
- Enter the IP address of the CMS in the browser. A login dialog appears.
- Enter the login details. The CMS homepage appears following a successful login.
- Click on <System>. The "System Menu" page appears.

- Click on <General Status Information>. This call triggers a command that reads and displays various CMS system parameters.
- In the "System Status" block, compare the serial number in the "Serial Number:" line with the delivery documentation.

The serial number has 7 digits and starts with 95xxxxx, e.g. 9515054. If the numbers are identical, this means you were able to connect to the correct system and the connection test was successful.

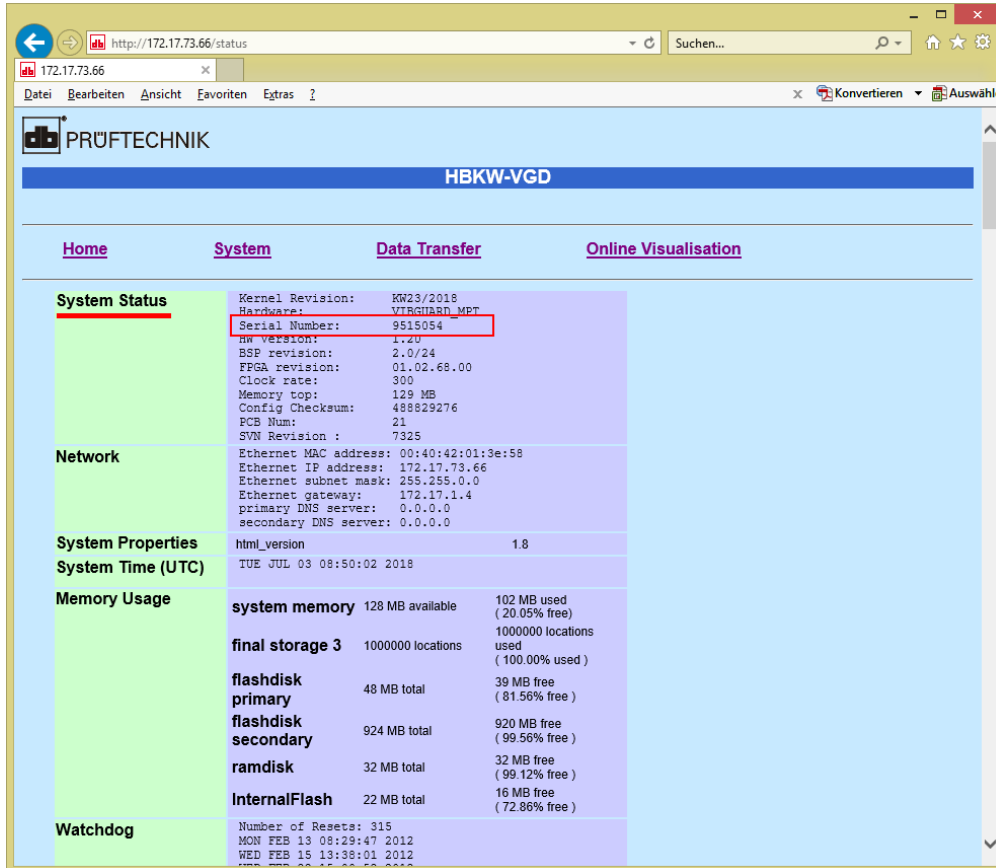

6 Network configuration

Upon delivery, a **standard network configuration** is stored in every VIBGUARD IIoT to allow access to the CMS on-site ("Connection test" on page 14).



If the CMS is integrated in an existing network, the network administrator will provide you with the network parameters to be set.



Note! Danger of data loss!

The network connection to the CMS can be lost due to incorrect entries and cannot be restored. Prior to saving, document the entries in a reproducible manner such as a screenshot that you can print out on paper, etc.

To change the network settings, proceed as follows:

- Establish a connection to the CMS.
- Enter the valid IP address of the CMS in the browser. A login dialog appears.
- Enter the login details.



Access to the configuration pages is only possible for user level 3 (highest level).

The CMS homepage appears following a successful login.

- Click on <System>. The "System Menu" page appears.
- Click on <Network Configuration> in the "Configuration" field. The "Enter System Settings" page appears.

- Enter the new network parameters ("Network Settings"): **IP Address / IP Mask / Gateway IP**.
- When using domain names, enter at least one accessible DNS server ("Domain Name Servers").
- Click on <Save Settings> to finish. A confirmation page appears.
- Click on <Initiate system reset> to trigger a system restart. The CMS can only be reached under the new IP address thereafter.

7 Sensor configuration

The settings of the sensor parameters are implemented via special configuration pages. These pages are part of the user interface in the VIBGUARD IIoT.

VIBGUARD IIoT starts the standard startup measurement configuration after the power supply has been switched on. This configuration is adapted to the specific system during startup.

- Enter the following address in the browser:
http://<IP-address of the CMS>/maintenance
A login dialog appears.
- Enter the login details for user level 3.



Access to the configuration pages is only possible for user level 3 (highest level).

The sensor configuration page ('Maintenance') appears after a successful login. Here you can set or adjust the sensors, the measuring ranges of said sensors, and the system-specific data.

Keyphasor

Channel	Sensor	Pulse/Rev.	Machine Tree			
P1	VIB 5.992-NX	1	Wind GL	Windturbine N90	Rotor m. Hauptlager	P1
P2	Unused	1	Wind GL	Windturbine N90	Reserve	P2

Analog Channel

Channel	Sensor	Amplification	Machine Tree			
A1	VIB 6.195	5.35 $\mu\text{A}/\text{ms}^{-2}$	Wind GL	Windturbine N90	Rotor m. Hauptlager	A1
A2	VIB 6.195	5.35 $\mu\text{A}/\text{ms}^{-2}$	Wind GL	Windturbine N90	Stimradgetriebe 1.Stufe	A2
A3	VIB 6.195	5.35 $\mu\text{A}/\text{ms}^{-2}$	Wind GL	Windturbine N90	Stimradgetriebe 1.Stufe	A3
A4	VIB 6.195	5.35 $\mu\text{A}/\text{ms}^{-2}$	Wind GL	Windturbine N90	Stimradgetriebe 2.Stufe	A4
A5	VIB 6.195	5.35 $\mu\text{A}/\text{ms}^{-2}$	Wind GL	Windturbine N90	Stimradgetriebe 2.Stufe	A5
A6	VIB 6.195	5.35 $\mu\text{A}/\text{ms}^{-2}$	Wind GL	Windturbine N90	SRS	A6
A7	VIB 6.195	5.35 $\mu\text{A}/\text{ms}^{-2}$	Wind GL	Windturbine N90	Generator	A7
A8	Unused	5.35 $\mu\text{A}/\text{ms}^{-2}$	Wind GL	Windturbine N90	Reserve	A8
A9	Unused	5.35 $\mu\text{A}/\text{ms}^{-2}$	Wind GL	Windturbine N90	Reserve	A9
A10	Unused	5.35 $\mu\text{A}/\text{ms}^{-2}$	Wind GL	Windturbine N90	Reserve	A10
A11	Unused	5.35 $\mu\text{A}/\text{ms}^{-2}$	Wind GL	Windturbine N90	Reserve	A11
A12	Unused	5.35 $\mu\text{A}/\text{ms}^{-2}$	Wind GL	Windturbine N90	Reserve	A12
A13	Unused	5.35 $\mu\text{A}/\text{ms}^{-2}$	Wind GL	Windturbine N90	Reserve	A13
A14	Unused	5.35 $\mu\text{A}/\text{ms}^{-2}$	Wind GL	Windturbine N90	Reserve	A14
A15	Unused	5.35 $\mu\text{A}/\text{ms}^{-2}$	Wind GL	Windturbine N90	Reserve	A15
A16	Unused	5.35 $\mu\text{A}/\text{ms}^{-2}$	Wind GL	Windturbine N90	Reserve	A16

Process Signals

Channel	Sensor	Quantity	Signal	Machine Tree		
A17	U_1	Label: U_1 Unit: V	Amplification: 1 V/V Offset: 0 V	Wind GL	Windturbine N90	Prozess A17
A18	I_20	Label: I_1 Unit: mA	Amplification: 1 mA/mA Offset: 0 mA	Wind GL	Windturbine N90	Prozess A18
A19	I_4_20	Label: I_2 Unit: mA	Amplification: 16 mA/mA Offset: 4 mA	Wind GL	Windturbine N90	Reserve A19
A20	U_2	Label: U_2	Amplification: 1 V/V	Wind GL	Windturbine N90	Reserve A20

Sensor configuration page ('Maintenance')

The page loads the data from the VIBGUARD IIoT and displays the current configuration of the measuring channels and the entries in the machine tree (**Machine Tree**) after startup.

There are three buttons at the top of the page. These buttons can be used to send commands to VIBGUARD IIoT (see further below).

If a channel is not available, this is indicated by the entry '**Unused**' in this line and the channel cannot be used. If a channel is not required, 'Unused' is to be selected at this point. Otherwise, a sensor error is displayed.

Configure the RPM sensor in the **Keyphasor** section:

- If necessary, set the connected sensor type in the **Sensor** column (e.g. VIB 5.992-NX).
- If necessary, enter the number of lobes per revolution in the **Pulse/Rev** column.
- Set unused Keyphasor channels to **Unused**.

You can edit all preconfigured analog input channels in the **Analog Channel** section.

- If necessary, set the connected sensor type in the **Sensor** column (e.g. VIB 6.195).
- Set unused analog channels to **Unused**.



The **Amplification** column cannot be edited for PRUFTECHNIK sensors as the values are fixed in this regard.

If necessary, set the process variables in the **Process Signals** section.

- Set the signal type in the **Sensor** column. Voltage or current can be selected.
- Enter the name (**Label**) and the unit (**Unit**) for the process variable in the **Quantity** column.
- Enter the factors (Amplification/Offset) for converting the measured value into the process variable in the **Signal** column.

Example:

The following values are to be entered for a wind sensor with 0-10 V signal and a final value of 50 m/s as well as for a power of 2.5 kW as a 4..20 mA signal:

Sensor	Label	Unit	Amplification	Offset
U_x	Wind speed	m/s	5	0
I_4_20	Power	kW	0.15625	0.625

- Enter the name of the system and the measurement location in the **Machine Tree** column.
- Click the **Save and Reboot** button after configuration. The parameters are transferred to the CMS and activated.

You can display and check the currently measured values using the **Display ISL Values** button.

If you want to send the entered parameters by email, click on **Send Configuration via Email**.



To archive the configuration, print the configuration page to a PDF file using the browser print function.

8 Sensor test

Using the overview page with all online readings ('Display Input Storage Location Values'), check whether the accelerometers are properly wired and working correctly.

- Connect to the CMS via the browser.
- Enter the login details. The homepage appears.
- Select the following link on the homepage:
 <Online Visualization> / <Display Input Storage Location Values>.

The following list appears:

The screenshot shows a web browser window with the URL `http://192.168.1.219/ssi/level1/dissl.htm`. The page title is "Display Input Storage Location Values". A button labeled "Display Values" is highlighted with a red box and an arrow pointing to it from the text "Aktualisieren". Below the button is a table of sensor readings. A red box highlights the first 22 rows of the table, which contain voltage readings for channels CH_101 through CH_120 and KP_101 through KP_102. To the right of this box, red text reads: "Spannungswerte CH_101 = A11 CH_102 = A12 ... CH_120 = A120 KP_101 = TP1 ...". Another red box highlights the row for "A1/Overall/acc/rms" with a value of "-99999.000". To the right of this row, red text reads: "Sensorfehler auf A1". To the left of this row, red text reads: "Sensor- bzw. Kanalbezeichnung".

1:	CH_101_Job/volt/mean:	0.177	V
2:	CH_102_Job/volt/mean:	3.689	V
3:	CH_103_Job/volt/mean:	3.683	V
4:	CH_104_Job/volt/mean:	3.675	V
5:	CH_105_Job/volt/mean:	3.760	V
6:	CH_106_Job/volt/mean:	3.724	V
7:	CH_107_Job/volt/mean:	3.704	V
8:	CH_108_Job/volt/mean:	0.178	V
9:	CH_109_Job/volt/mean:	0.175	V
10:	CH_110_Job/volt/mean:	0.178	V
11:	CH_111_Job/volt/mean:	0.175	V
12:	CH_112_Job/volt/mean:	0.172	V
13:	CH_113_Job/volt/mean:	0.201	V
14:	CH_114_Job/volt/mean:	0.188	V
15:	CH_115_Job/volt/mean:	0.184	V
16:	CH_116_Job/volt/mean:	0.184	V
17:	CH_117_Job/volt/mean:	2.465	V
18:	CH_118_Job/volt/mean:	2.465	V
19:	CH_119_Job/volt/mean:	1.768	V
20:	CH_120_Job/volt/mean:	2.336	V
21:	KP_101_Job/volt/mean:	0.054	V
22:	KP_102_Job/volt/mean:	0.000	V
23:	TEMP_123_Job/Temp/mean:	316.148	K
24:	BATTERY_V_124_Job/volt/mean:	3.181	V
25:	24V_125_Job/volt/mean:	23.537	V
26:	3.3_V_126_Job/volt/mean:	3.276	V
27:	5_V_127_Job/volt/mean:	5.292	V
28:	LOAD_128_Job/udef/mean:	0.662	%
29:	A20/U_2/udef/mean:	2.336	V
30:	A8/Overall/acc/rms:	0.003	m/s^2
31:	A19/I_2/udef/mean:	0.855	mA
32:	A16/Overall/acc/rms:	0.003	m/s^2
33:	A13/Overall/acc/rms:	0.003	m/s^2
34:	A10/Overall/acc/rms:	0.003	m/s^2
35:	A11/Overall/acc/rms:	0.003	m/s^2
36:	A9/Overall/acc/rms:	0.003	m/s^2
37:	A12/Overall/acc/rms:	0.003	m/s^2
38:	A14/Overall/acc/rms:	0.003	m/s^2
39:	A15/Overall/acc/rms:	0.003	m/s^2
40:	P2/Machine Speed/rpm:	13.788	Hz
41:	A1/Overall/acc/rms:	-99999.000	m/s^2
42:	P1/Machine Speed/rpm:	13.788	Hz
43:	A17/U_1/udef/mean:	2.463	V
44:	A18/I_1/udef/mean:	24.629	mA
45:	A4/Overall/acc/rms:	0.017	m/s^2
46:	A5/Overall/acc/rms:	0.329	m/s^2
47:	A3/Overall/acc/rms:	0.137	m/s^2
48:	A2/Overall/acc/rms:	0.010	m/s^2

List of online readings

The left column states the number of the input memory in which the respective readings are stored. The first 22 memories contain the values for the **supply voltage** of the respective channels. The assignment is derived from the following schema:

- CH_101 = A11 (-> It is preferable to connect sensor A1 here)
- CH_102 = A12 (-> It is preferable to connect sensor A2 here)
- ...
- CH_116 = A116 (Analog input: CLD, IEPE or U)

- CH_117 = AI17 (-> A process signal, e.g. generator power connected)
- CH_118 = AI18 (-> A process signal, e.g. wind speed connected)
- ...
- CH_120 = AI20 (-> A process signal)
- KP_101 = TP1 (-> It is preferable to connect the RPM sensor here)
- KP_102 = TP2

The other lines indicate the values for the measured variable. The channel is always at the start of the second column. The status of a measurement or an error in the measurement chain is displayed in color:

OK	Alarm	Warning	Prewarning	Sensor error
----	-------	---------	------------	--------------

8.1 Sensor position

For reliable machine diagnostics, the sensors must be wired to the input channels provided for this purpose. Use the cable break detection in the CMS to check that the sensor position is correct. In the event of a cable break, the relevant status LED flashes **orange** on the system module.

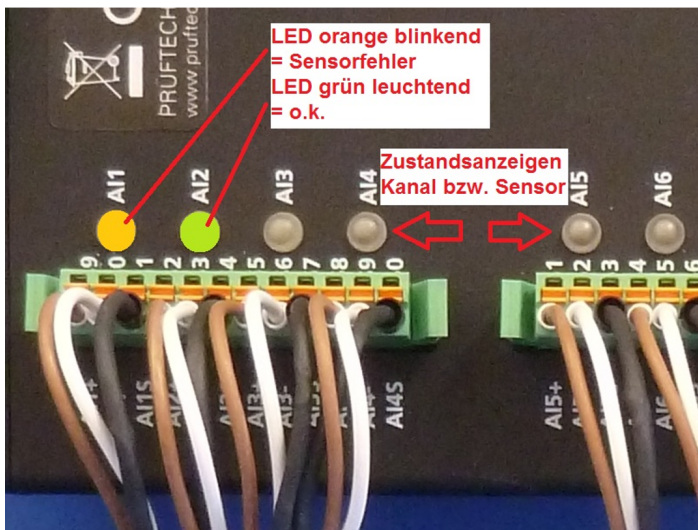

Status LED on the terminal block

To simulate a cable break in the measuring section, proceed as follows:

- Disconnect the cable connector plug from the sensor and remove it. The following scenarios are possible:
 - If the sensor is correctly wired, the status LED on the corresponding channel responds and flashes orange.
 - If the status LED responds on a different channel, the connections on the terminal block are out of sequence. Replace the connections on the terminal block and repeat the position test for all sensors.



It can take a few moments for the status LED to respond. This is because the CMS regularly performs over-all value calculations in the context of the measurement configuration.

- Reconnect the cable plug to the sensor and wait until the status LED displays the OK state (green) again.
- Repeat these steps for all sensors.

9 Process signals

On the overview page of all online values ("Sensor test" on page 19), check whether the values of the process signals match the values from the system controller. The assignment of the channels is derived from the sensor configuration page ("Sensor configuration" on page 17).

Enter all the values in the startup report and calculate the percentage **deviation** as well. If the deviation is greater than 10%, check the configuration.



The displayed values are the raw values of the respective signal such as mA for current, V for voltage and Hz for RPM and therefore need to be converted.

Examples for converting signal values into process values

4..20mA signal

- Final value, generator power = 2.5 MW
- Signal value read off = 6.3 mA
- Process value calculated: $2.5 \text{ MW} / 16\text{mA} * (6.3\text{mA}-4\text{mA}) = \mathbf{0.36 \text{ MW}}$

0-20mA signal

- Final value, signal value = see previous example
- Process value calculated: $2.5 \text{ MW} / 20\text{mA} * 6.3\text{mA} = \mathbf{0.79 \text{ MW}}$

0-10V signal

- Final value, generator power = 2.5 MW
- Signal value read off = 6.3 V
- Process value calculated: $2.5 \text{ MW} / 10\text{V} * 6.3\text{V} = \mathbf{1.58 \text{ MW}}$

Rotational frequency

- Number of trigger marks (lobes) = 5
- Frequency value read off = 28.6 Hz
- RPM calculated: $\text{Revolutions/minutes} = 28.6 \text{ Hz} * 60 \text{ s/min} / 5 = \mathbf{343 \text{ RPM}}$

Example: Calculation of the percentage deviation

Formula: $\langle \text{Percentage deviation} \rangle = 100\% - (100\% / \langle \text{expected value} \rangle * \langle \text{measured value} \rangle)$

- (expected) value read off of the system controller: 0.39 MW
- Signal value displayed (converted): 0.36 MW
- Deviation in %: $100\% - (100\% / 0.39 \text{ MW} * 0.36 \text{ MW}) = \mathbf{7.69 \%} < \mathbf{\pm 10 \%} \rightarrow \text{o.k.}$



Ensure that you compare the values in the upper third of the measuring range if possible. A comparison with very small values can lead to greater deviations due to the resolution being too low and due to signal fluctuations!

10 Configuring Email transmission

Prior to testing email transmission, ensure that the active (HTTP) connection to the CMS does not affect communication with the SMTP server (email).

i When dialing in via a dial-up unit, the communication path to the SMTP server can be interrupted. For this reason, the email transmission test is usually carried out using a direct connection to the system (on-site).

Requirements for email transmission:

- Network connection to the router or to the Internet
- Gateway address is available and correct
- Email configuration has been set up properly
- CMS is ready for operation

When integrating the system in an existing network, the following requirements are to be discussed with the operator or administrator of the network:

- Network parameters for **Gateway** and **SMTP server**
- SMTP server is to be enabled for email transmission by the CMS

10.1 Configuration

- Click on <System> on the homepage. The “System Menu” page appears.
- Click on <Email Configuration> in the “Configuration” field. The menu with the email parameters appears. The menu is split into three sections:
 - **Email configuration display:** Configure sender data
 - **Account configuration:** Create an email account
 - **Email configuration:** Configure Email

The screenshot displays the 'Email configuration display' section with the following data:

Sender name	Sender email address
VIBGUARD	mail@VIBGUARD.com

The 'account configuration' section contains a table:

ID	Typ	Server URL	Authorization	Pop account	Add New
2	smtp		none	0	Edit / delete

The 'Email configuration' section includes a table:

ID	Subject	Attachment	Add New
1	test		Edit / Delete

Below the table, there are fields for 'Recipient Name' and 'Email address', each with an 'Add New' link. At the bottom, a red message reads: 'Configuration changed but config file is not updated!'.

Set email parameters

Sender

- Click on <Edit> under "Email configuration display" to open the input mask for the **Sender data**.
- Enter a **Name** in the "Sender Name" field.
The name can be chosen arbitrarily, but it should have a reference to the monitored system.
- Enter an **Email address** in the "Email Address" field.
This can also be chosen arbitrarily, but it must contain an existing domain (address part after the @ sign) as some servers check this during transmission.
- To conclude, click on <Save Settings> and confirm the following message with <OK>.



Note!

Pay attention to the correct spelling of the email address: **NO** spaces, special characters, umlauts. Otherwise, transmission will not take place.

Email account

The emails are usually sent via or directly to an SMTP server that contains the recipient's mailbox.

- Click on <Edit> under "account configuration" to edit an existing account or click on <Add New> to create a new account. The input mask for the email account appears:

Settings for the email account

- **Account ID:** Sequential number for the account, e.g. "2".
- **Account type:** Set the **SMTP** here.
- **Account Authorization:** Set the authentication method on the SMTP server here.
- **Server URL:** Enter the absolute IP address of the SMTP server or the domain name here.



When using a domain name, at least one accessible DNS server is to be specified, otherwise the name cannot be resolved. Enter the DNS server under **Homepage / <System> / <Network Configuration>**. This is not absolutely necessary if you enter an absolute IP address.

- **User name:** Username, only if authentication on the SMTP server is set
- **Password:** Password, only if authentication on the SMTP server is set
- **Network port:** Set **25** here (SMTP server)
- **Pop account id:** leave empty; sequential number, only necessary for "Account Authorization" and "POP3" (Account type)
- **Max. bytes per mail:** If there is a specified limit to the size of the email, such a limit is to be entered in bytes. The email is then split if the size is exceeded.
- **Use SSL:** Set the encryption method (SSL, STARTTLS or NONE) here if necessary
- To conclude, click on <Save Settings> and confirm the following message with <OK>.

Email configuration

You can configure the email to be sent in this section.

- Click on <Edit> under "Email configuration" to edit an existing configuration or click on <Add New> to create a new configuration. The input mask for the email configuration appears:

Email configuration (type and subject)

- **Email ID:** Sequential number
- **Email type:** "Status", "System" and "Unknown" can be selected:
 - **Status:** Channel status e.g. sensor error, warning, alarm etc. An email of this type is sent directly to a user.
 - **System:** System status e.g. alive and data transmission. These emails are intended for communication between the CMS and the OMNITREND Center software.
 - **Unknown:** This type can contain any information for a recipient.



Set the type to "Unknown" for the **Test transmission**.

- **Email Subject:** Email subject line; this should have a meaningful reference to the content.
- **Attachment type:** If you want the email to contain an attachment, select whether a specific file ("File") or all measurement data ("All Measurement Data") is to be sent.

 Set the type to “None” for the **Test transmission**.

- **Attachment file:** Enter the file that is to be sent as an attachment here.
- To conclude, click on <Save Settings> and confirm the following message with <OK>.

The "Email configuration" section now contains another field for entering the recipient data "Recipient Name".

- Click on <Add New> under "Email configuration" / "Recipient Name" to enter the recipient data. The input mask for the recipient data appears:

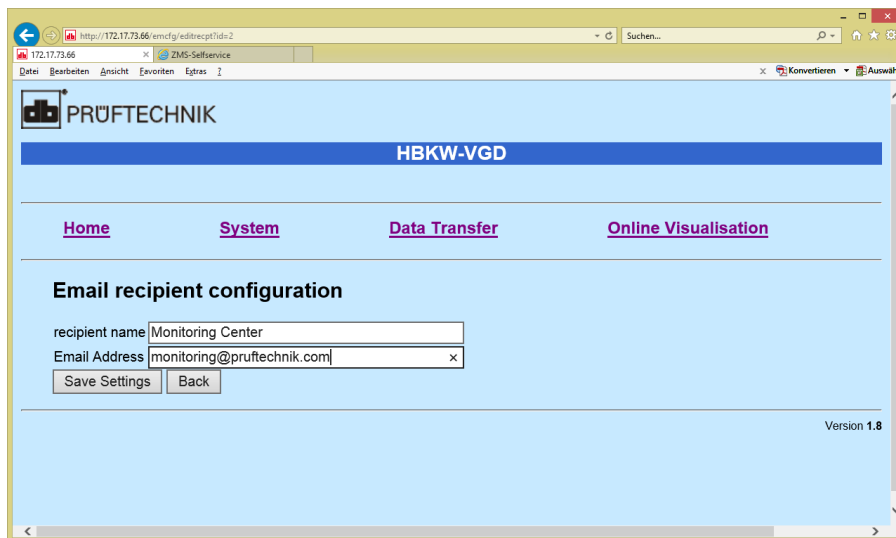

Configuring the Email recipient

- **Recipient name:** The recipient name corresponds to the addressee of the email. If this information is not known, any meaningful identifier can be entered.
- **Email Address:** Email address of the recipient.
- To conclude, click on <Save Settings> and confirm the following message with <OK>.

Backing up the Email configuration

The data is now in the temporary memory and only needs to be backed up in the “email.xml” configuration file.

- Click on <Save > and confirm the following message with <OK>.

Now that you have entered and saved all the requisite information and parameters, carry out a transmission test to determine whether emails arrive at the recipient as intended.

11 Sending a test email

The CMS processes the programmed measurement tasks autonomously. The stored measurement data is processed on the system, evaluated and made available for transmission via the data network. Data is transmitted to an external service center at regular intervals for further analyses and condition diagnoses. Data transmission is carried out in the course of system and email configuration. Further details of this can be found in the previous section.

This section describes how to send a test email via the existing network infrastructure.

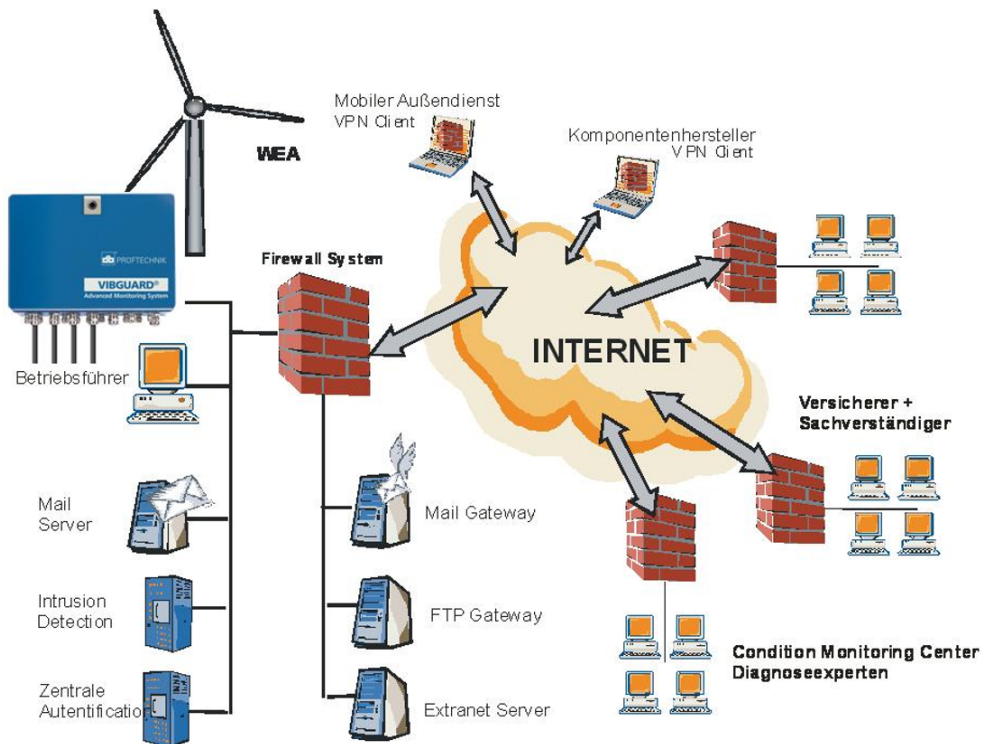

Typical network structure

Prerequisites

- The CMS is connected to the Internet via Ethernet.
- SMTP server and gateway are in place
- Email has been configured properly

Test objective

- To check whether the test email is sent correctly via the SMTP server
- Evaluate feedback from the SMTP server.



Receipt of the email is not of relevance to this test.

Sending a test email

- Connect to the CMS via the browser.
- Enter the login details. The homepage appears.

- Click on the <System> link. The 'System Menu' page appears.
- Click on the <Send Emails> link in the **Administration** section. The 'Send Emails' page appears.
- Click on the <Send test email> link.
The CMS sends a test email. Depending on the connection setup, it may take a few moments until the email is sent. A confirmation page provides the response from the SMTP server.

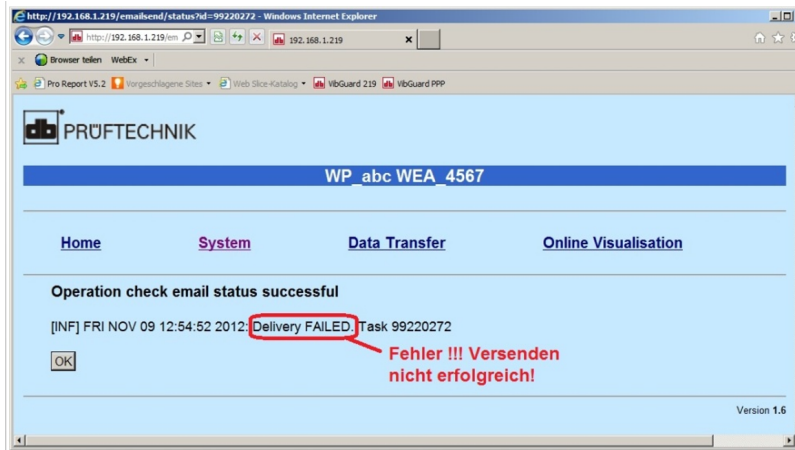

- Note the outcome in the setup log.



In the event of an error, check the email configuration and ask the operator or administrator if the SMTP server is working properly. Arrange for an inspection if necessary.



Printed in Germany LIT 78.221.EN.10.2018

 **PRÜFTECHNIK**

Fluke Deutschland GmbH
Freisinger Str. 34
85737 Ismaning, Germany
+ 49 89 99616-0
www.pruftechnik.com

Productive Maintenance Technology