

FLUKE®

Reliability

VIBXPERT® II

db® PRÜFTECHNIK

**Operating Instructions
Balancing**

VIBXPERT® II
Dual channel
FFT data collector
and signal analyzer

'Balancing'
Operating Instructions

Series: VIB 5.310

Firmware version: 3.2x

Edition: December 2019

Order no.: LIT 53.202.EN

Translation of the german manual

LEGAL NOTES

Copyright

Both this manual and the product it describes are copyrighted. All rights belong to the publisher. The manual may not be copied, reproduced, translated or made accessible to a third party in any form, neither in its entirety nor as an excerpt.

Disclaimer

No liability may be claimed against the publisher regarding the product described in this manual. The publisher assumes no liability for accuracy of the manual contents. Furthermore, under no circumstances may the publisher be held liable for direct or indirect damage of any kind resulting from use of the product or the manual, even if the publisher has expressly indicated the potential for occurrence of such damage. The publisher assumes no liability for any product defects. This warranty and liability limitation applies to all distributors and sales partners as well.

Trademarks

The trademarks mentioned in this manual are generally noted as such and are the property of their owners. Lack of such designation does not imply, however, that names are not protected by trademark laws.

© Fluke Corporation, all rights reserved

Foreword

Congratulations! And thank you for choosing the dynamic balancing option in one or two planes to expand your VIBXPERT II FFT data collector and signal analyzer*.

* Also called 'VIBXPERT' and 'measurement instrument' in this manual.

The balancing module is based on the well-known "influencing coefficients method" and is distinguished by its efficiency and ease of use. The measurement process implemented in the instrument has been optimized by a new knowledge-based algorithm. Perfectly matched measurement settings save time-intensive preparation and also enable the automation of recurrent tasks. Simple operation is guaranteed by intuitive graphic guidance which leads the user through the balancing procedure step by step. A number of methods are available to compensate rotor imbalance: free balancing, fixed weight, fixed location or tape measure balancing. If necessary, VIBXPERT can combine all mounted weights into a single new weight. If you do not wish to attach a balancing weight to the rotor, VIBXPERT will calculate the mass that should be milled from the rotor.

And just think! VIBXPERT even grows to meet your future requirements. The latest analysis and diagnostic functions are added on a regular basis and made available as an update. This ensures that you are always have the most modern equipment.

For further information visit us on the Internet at:

<http://www.pruftechnik.com>

And if you are ever faced with an unsolvable task, our specialists from the PRÜFTECHNIK Service and Diagnostic Center (SDIC) will be glad to assist you. Just send an e-mail:

service@pruftechnik.com

About this manual

This manual describes the operation of the measurement device in the optional "Balancing" mode. The description of the measurement device and operation in the "Multimode" and "Route" modes appears in the VIBXPERT operating instructions (LIT 53.201.EN).

If you do not have immediate access to this manual, direct help is contained in the device and can be opened with the HELP key.

This manual is valid for firmware version 3.2x.

HELP

Contents

Chapter 1: Introduction	1-5
Safety	1-5
Symbols	1-5
Intended use	1-5
Conformity	1-5
General safety.....	1-6
Registration	1-7
 Chapter 2: Balancing	 2-1
Balancing on machines with rotating masses.....	2-3
Diagnosis.....	2-4
Preparatory activities	2-5
Assembly	2-5
Operation	2-9
Balancing in one plane	2-11
Measuring the initial imbalance.....	2-12
Trial run.....	2-12
Trim run.....	2-13
Undoing balancing runs.....	2-14
Balancing in two planes.....	2-15
Overview of the measurement procedure.....	2-15
Determining the measurement plane & balancing plane A.....	2-15
Measuring the initial imbalance in plane A and plane B	2-15
Trial run.....	2-16
Trim run.....	2-16
Saving the result.....	2-16
Evaluation of the data	2-17
Options for balancing	2-18
1. Combining balancing weights.....	2-18
2. Changing the correction mode (Tools menu / Machine setup)	2-19
3. Removing the balancing weight (Tools menu/ Machine setup)	2-21
4. Check functions (Tools menu / Machine setup)	2-21
5. Entering the balancing radius and rotor mass later (Tools)	2-22
6. Speed for balance quality (Tools menu / Machine setup).....	2-22
7. Influence coefficient (Tools menu).....	2-22
Display setup	2-24
Printing the balancing report.....	2-25
Setup parameters	2-26
Machine setup	2-26
Measurement setup	2-29
Balancing with a control plane	2-30
Balance calculator	2-31
Operation of the balance calculator	2-32
 Chapter 3: Appendix	 3-1
Balancing quality classes and groups of rigid balancing bodies	3-1
Messages during balancing	3-2
Emergency storage.....	3-4
 Index	 3-5

Chapter 1: Introduction

Safety

You must carefully read and understand the safety instructions in the VIBXPERT operating manual (LIT 53.201.EN) as well as the following safety instructions for balancing before starting work with the measurement device.

Symbols



WARNING!

Danger to life and limb.



ATTENTION

Danger of improper operation which can cause damage.



NOTE

Tips on operation as well as information about balancing.

Intended use

VIBXPERT is intended for use as a portable balancing device for the balancing of *stationary* machines equipped *solely with rotating components (rotors)*, e.g. turbine rotors, inductors, circulating pumps, centrifugal compressors, fans, etc. This does not include machines with oscillating components, e.g. all reciprocating machines.

VIBXPERT can be used without any restrictions for the balancing of rigid rotors. Elastic (soft) rotors may only be balanced with VIBXPERT at the resonant frequency ($\pm 25\%$) by an experienced user. The measurement instrument and its accessories may only be operated by authorized personnel.

PRÜFTECHNIK Condition Monitoring assumes no responsibility for any damage arising from improper use.

Conformity

The product complies with the relevant European directives. The declaration of conformity is available as a PDF and may be downloaded from the PRÜFTECHNIK homepage at:

www.pruftechnik.com/certificates



General safety

- The applicable safety regulations must be observed when performing measurements on running machines.
- When assembling measurement components, make sure that no holders, cables, etc. project into the range of movement of rotating machine parts.
- The respective manufacturer's instructions must be followed when mounting balancing weights.
Make sure that attachment points for balancing weights to be welded on are clean; clamp the ground electrode of the welding device onto the rotor and not onto the machine.
For balancing weights that need to be screwed on, the maximum permitted RPM of the motor must be observed.
- The machine must be disconnected in order to work on the rotor and must be secured against being switched on again in accordance with the applicable regulations.
- Before the first measurement (initial run), it is important to ensure that the preparatory activities have been carried out correctly and completely. In addition to the assembly of measurement components, particular attention must be paid to the correct input of parameters in the machine setup. If an incorrect rotor mass is entered, a trial weight that is too large may be calculated as a result. This could have serious consequences for personnel and machine!
- No one is allowed to remain in the radial vicinity of the rotor during balancing runs. This area must be properly secured against unauthorized entry. If the trial weight of the rotor on a running machine detaches, there is a risk of fatal injury in this area!
- If the rotor is in a protective housing, any gaps in the housing must be closed before switching on the machine.
- The permitted switch-on frequency of the machine may not be exceeded. Otherwise, the motor could be damaged.
- The cause of the imbalance must be determined before balancing, and must be corrected if necessary (e.g. remove any caking on the rotor, weld any cracks on the impeller or replace the impeller).

Registration

The balancing software is already contained in the instrument and must be activated by entering a password. Changes to the instrument or the loading of additional software are not necessary.

Entering the password

The password is given on the certificate contained in the scope of delivery of the balancing module.

- Click on "Device Setup" in the start screen.
- Click on "Registration" in the "Device Setup" screen (see below).
- Click on the "Balancing" in the "Registration" screen and enter the registration password in the text editor.

Registration is now complete and the new operating mode now appears on the start screen.

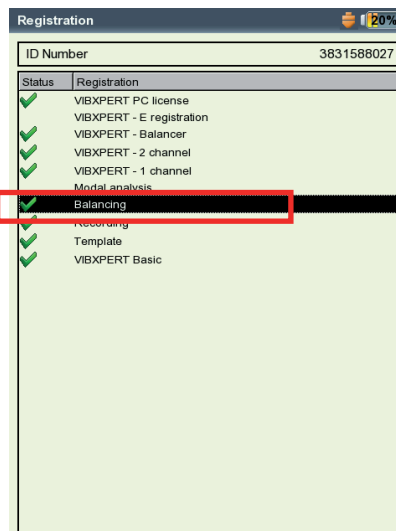
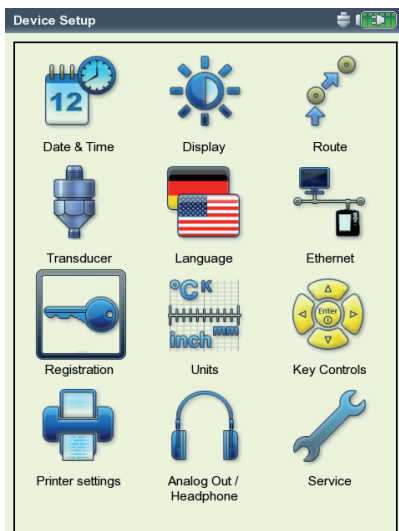

Device Setup - Registration

'Balancing' module is registered

Chapter 2: Balancing

Increased vibrations on machines are undesirable phenomena. They impair product quality, place additional strain on components and, last but not least, reduce operational safety. The most frequent cause for these increased vibrations is imbalance. The high centrifugal forces that result lead to premature wear of machine components such as bearings and seals, for example. Thus, the objective of balancing rotors is to limit bearing forces and shaft deformations to acceptable values.

VIBXPERT enables imbalance to be reliably detected and quickly corrected. The balancing results are automatically compared with the evaluation yardsticks of DIN ISO 1940 for the balancing condition of rotating rigid bodies.

Imbalance

If a rotor is correctly balanced and this rotor is placed on balancing rollers, any additional mass placed on the rotor will cause this mass to immediately move downwards. This process is called 'roll off'.

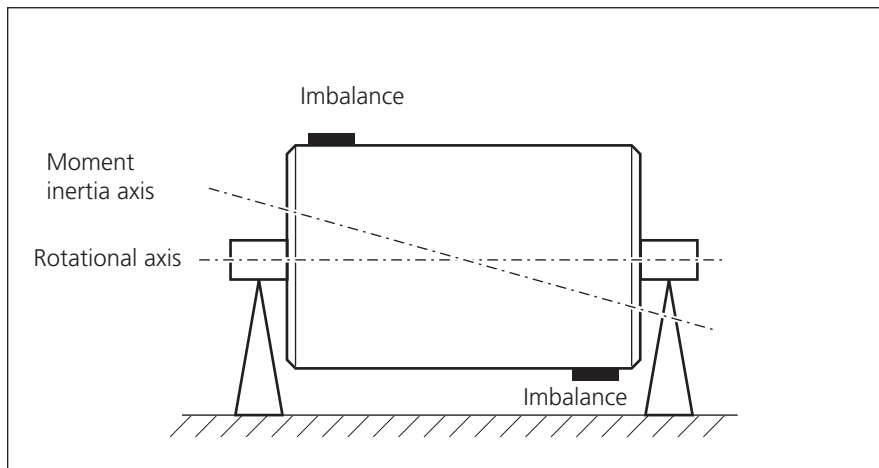

Couple (dynamic) imbalance

If this rotor is now turned with the balancing RPM, a centrifugal force is caused perpendicular to the rotational axis by the displacement of the center of gravity.

A static imbalance has to be corrected using 1-plane balancing because the planes of imbalance and center of gravity coincide. Considered from the measurement plane, the imbalance is static at a single location.

If two equally heavy masses are attached to a completely balanced rotor so that they lie exactly opposite in two separately lying radial planes, this is called a couple imbalance (or a dynamic imbalance). The center of gravity of the rotor remains on the rotational axis. The imbalances cause a centrifugal torque that gives rise to opposing forces of the same size in the bearings. Such imbalances can only be balanced using two-plane "dynamic" balancing - one-plane balancing would not bring any improvement.

If an individual imbalance which does not lie on the center of gravity is added to a completely balanced rotor in one plane, it is called a quasi static imbalance. It corresponds to the combination of a static imbalance and a couple imbalance and is usually compensated in two planes.

Basically, the consideration of whether to carry out balancing in one or two planes depends on the specific machine situation, i.e. on the balancing behavior of the rotor and the vibration behavior of the machine. Simultaneous balancing in two planes is quicker and more precise than successive balancing measurements in each of two individual planes. Residual errors that are accumulated in sequential balancing are therefore prevented. The distance/diameter ratio of the balancing planes is normally an important decision criterion.

Two-plane balancing under operating conditions using an optical trigger and two vibration transducers.

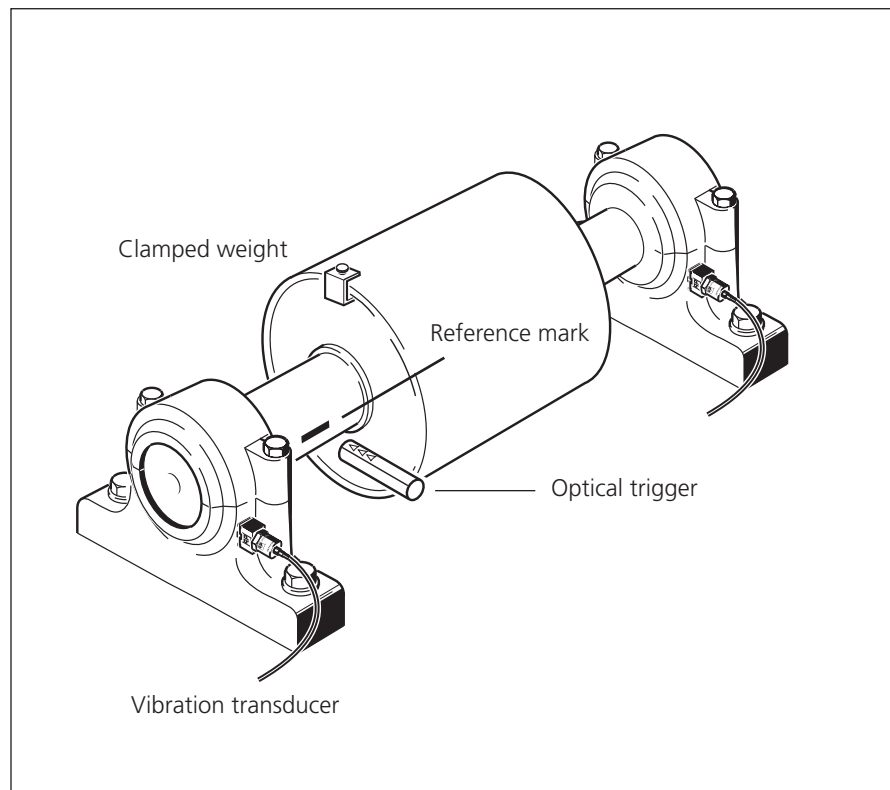

Balancing on machines with rotating masses

The VIBXPERT balancing module is based on the well-known 'influence coefficients method':

First, VIBXPERT measures the vibration amplitude and phase angle and the vibration caused by the imbalance or so-called 'initial imbalance'. A defined trial weight* is then attached and the instrument measures the resulting change in amplitude and phase. VIBXPERT calculates the influence coefficients from the difference between both vibrations according to magnitude and phase which precisely indicates the location and magnitude of the balancing weight with regard to the position and size of the trial weight. In the case of two-plane balancing, the calculation of the influence of the mass is also taken into account in the other plane. All so-called 'rigid' rotors are balanced using this method.

A rigid rotor mainly exhibits proportional vibration behavior if the balancing weight and angle change. In the case of fixed rotational speed, weaknesses or resonances in the mounting have no influence on the vibration behavior. If the machine rotates at a variable speed, it frequently exhibits different vibration behavior for each revolution and, therefore, has to be balanced several times over the range of low-speed to high-speed running.

Soft rotors do not exhibit the expected proportional behavior with the calculated balancing weight, and the coefficients method does not apply. Such rotors can normally only be balanced in balancing machines using a force measuring procedure.

* VIBXPERT calculates the weight and location for the required trial mass in such a manner that it usually results in a reduction in the existing imbalance and in the associated vibration load. This has the added advantage that the trial mass does not have to be removed again but can remain on the machine indefinitely.

Diagnosis

Before beginning the balancing procedure, first make sure that the cause for the adversely affected smooth running of the rotors is actually an imbalance. Furthermore, a vibration diagnosis indicates which balancing method is the most suitable.

A series of coordinated measurement tasks are available for the diagnosis of an imbalance:



- Click on "Balancing" in the start screen and open the 'Diagnosis' tab (see below):

Overall value - vibration velocity



Records the broadband vibration of the machine in order to document the actual condition before and after balancing. This also makes it possible to determine the measurement location with the highest vibration values where the sensors should be mounted.

RPM



Measures the rotor RPM. If a machine setup is used for balancing, this parameter is required in order to calculate the resulting centrifugal forces.

Phase measurement - one / two planes



Records the amplitude and phase angle of the RPM-synchronous vibration signal. This allows, for example, the type of imbalance (static / dynamic) to be determined.

Spectrum & Time waveform - vibration velocity



Measures the FFT spectrum and time waveform. If the 1st harmonic dominates the spectrum, an imbalance is probably the cause for the poor running.

Left: Diagnosis measurement

Right: FFT spectrum for diagnosis
1st RPM harmonic vibration dominates -> imbalance

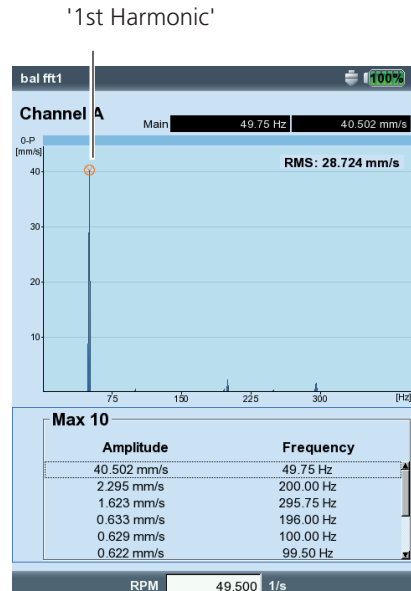
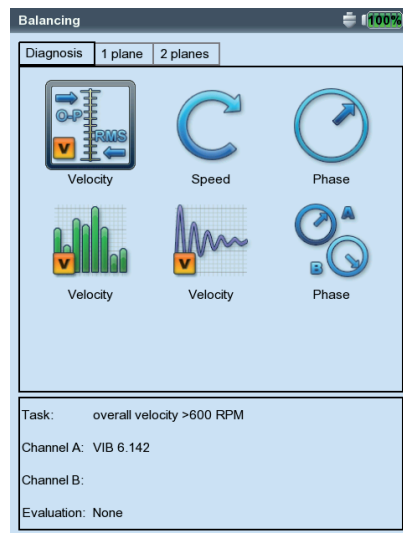

Preparatory activities

Preparations include the mounting of the measurement components.

The machine must be...
 ... disconnected before carrying out any work on the machine.
 ... protected against being switched on again inadvertently!



Assembly

1. Find out the cause of the imbalance visually and fix it if possible, e.g.: Remove any coatings from the impeller, fasten any loose balancing weights or tighten any loose screws on the foundation.

If the machine cannot be balanced in-situ, it must be firmly mounted on a rigid foundation (directly on frames or on vibration isolators).



2. Determine the measurement and balancing planes (see figure on next page). Mount the vibration transducer on the bearing housing at the measurement location with the highest vibration values. Note that:

- The measurement plane should be in the middle of the bearing and close to the balancing plane and the plane of the center of gravity (e.g. impeller side, rotor).
- Vibrations are transferred via the outer ring of a bearing in a radial direction. Thus, mount the transducer on the side (horizontal) or on the top of the bearing (vertical).
- The transducer should be attached as close as possible to the bearing. Prevent signal attenuation due to excessively long transmission paths or bearing covers. The direction of measurement must correspond to the main direction of vibration (mostly horizontal). If the measurement direction is horizontal, mount the transducer on the lower half of the bearing housing.
- Wherever possible, use transducers which are screwed onto the machine or attach the transducer using a magnetic adapter (VIB 3.420). The transducer should not be attached to components with intrinsic vibrations, e.g. covers.
- Hand-held probes are not suitable for balancing!
- Only for balancing in two planes: Determine the second plane (B) in the same way.

3. Assess the machine smoothness.

- Measure the vibration velocity and record an FFT spectrum if the measurement values are too high (see DIN ISO 10816-3). If high vibration signals appear at the rotational frequency, there is an imbalance that must be corrected by balancing.
- Save the measured values in order to be able to compare them later with the values measured after the balancing procedure.

**Note**

High axial amplitudes indicate a large imbalance of torque which cannot be balanced using the methods described here.

4. Attach a reference mark on the shaft for the trigger sensor while the machine is at a standstill.
 - Use a light reinforcing (e.g. reflective tape VIB 3.306) or light damping (black, high-contrast line on a bright surface) mark and place this parallel to the shaft axis and perpendicular to the direction of rotation.
TIP: Place the mark as close as possible to the groove of the adjusting spring. The mark should be easy to find and the measurement results can be reproduced more easily.
 - Angle convention: the angular reference mark lies at 0° ; the fixing angle ϕ for the balancing weight is counted against the direction of shaft rotation.
TIP: Number the blades corresponding to the counting direction of the fixing angle. Blade no. 1 is taken as the 0° position.
 - Active edge: Define whether the edge of the incoming trigger mark or outgoing trigger mark on the shaft is to be used as the reference signal. The setting can be made under 'Transducer/Keyphaser' in the Device Setup. Observe the signal response for the different types of reference marks (s. next page).

Typical assembly:

Measurement and balancing plane A & B, reference marks, fixing angle ϕ

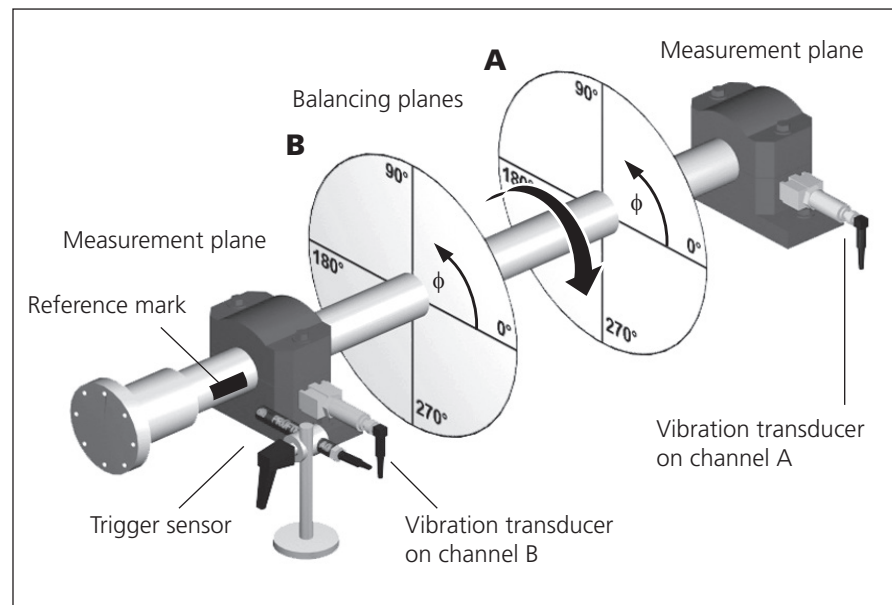

5. Mount the laser trigger sensor (VIB 6.631) with the trigger bracket (VIB 6.632) on the machine.
6. Connect the vibration transducer to the measurement instrument.

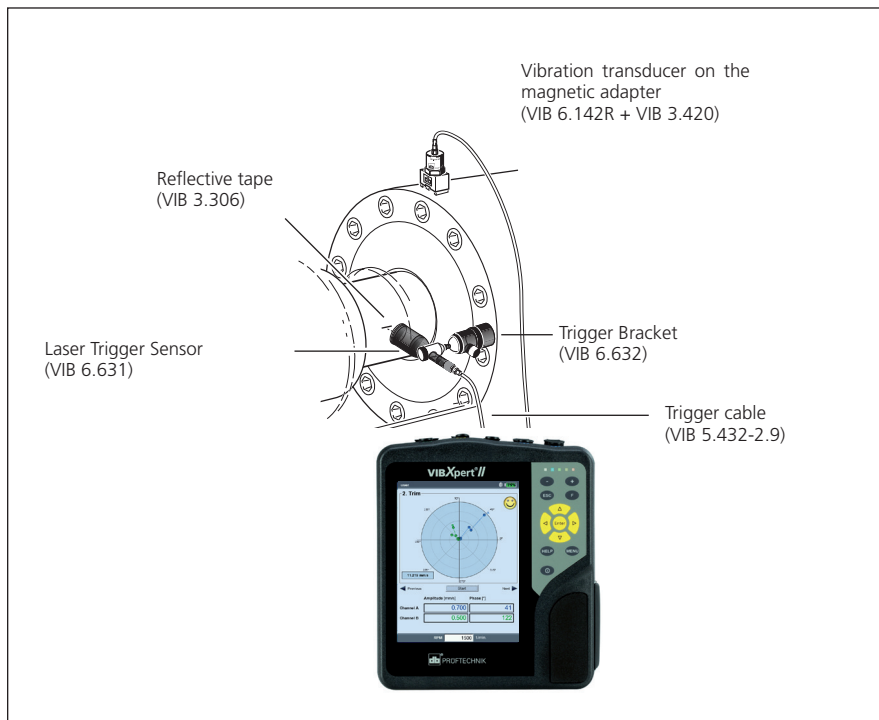

After completing the preparatory activities, ensure the following:

- The balancing RPM should lie as close as possible to the operating RPM. If this is not possible due to high vibration values, start at a lower RPM and approach the operating RPM step-by-step in several balancing runs.
Minimum balancing RPM: 30 cpm. (= 0,5 Hz)
- Pay attention to potential resonance points and, if there is any doubt, perform a coast down measurement!
- The RPM must remain constant during a balancing run! Otherwise, the balancing run must be restarted.
- The rotor must reach operating temperature during the measurement (e.g. if the rotor works in a hot air stream).
- Often the static imbalance is dominant at vibration values above 10 mm/s. First, compensate this using 1-plane balancing before proceeding with 2-plane balancing.
- Before starting the initial balancing run, check again that all measurement components have been correctly installed.
- If a machine setup is used for the balancing procedure, check the specified parameters. Incorrect rotor data may result in the calculation of excessive trial weights under certain circumstances!



Note

Operation

If you are not yet familiar with operation in balancing mode, please note the following instructions:

Settings

All settings necessary for the measurement and evaluation of a balancing run are made in setup menus. The following setups can only be changed before a balancing run is begun:

- Measurement setup: measurement settings (see p. 2-29)
- Transducer setup: parameters of the transducer in use
- Machine setup: data on rotor and balancing-related settings (see p. 2-26ff.)

The settings in the following two setup menus can also be changed during a balancing run:

- Display setup: display settings (see p. 2-24).
- Tools: balancing-related settings and parameters that can be changed during a balancing run (see p. 2-19ff.).

Display

In each balancing run, two main screens appear:

Data screen

The upper half of the screen shows the balancing weights and their positions on the rotor. The lower half contains the measurement data and balancing weights of all completed runs. If a machine setup is used, it shows the balancing quality attained and the resulting centrifugal force on the rotor.

Measurement screen

The measurement values (amplitude and phase angle) are displayed and the imbalance pointer is shown in a polar diagram.

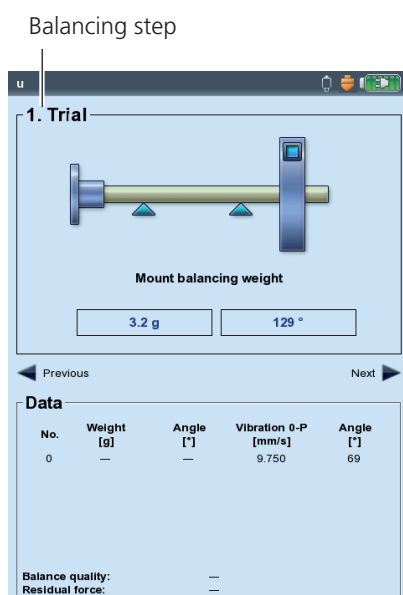

Left:
Data screen

Right:
Measurement screen

The respective balancing step appears on the upper left of both screens:

0. Initial imbalance

Measurement of the original imbalance; if the vibration values are within the tolerance range, the rotor is balanced. Otherwise, the balancing weights must be placed on the rotor according to the following balancing steps.

1st trial run

The influence of the attached trial weights is measured and the resulting balancing weight is calculated.

2. Trim to ..N. Trim

Trim runs for reduction of rotor imbalance.

The initial imbalance pointer represents the starting point of the balancing procedure. The arrow direction indicates the path of the balancing runs. A dashed pointer marks a balancing run in which the weight was removed (see figure below).

Zoom

VIBXPRT automatically scales the display range with respect to the last two balancing runs. To magnify the view, press the "+" button repeatedly. If the initial imbalance moves out of the display range, the maximum range is also given as a percentage of the initial imbalance.



Navigation

To scroll forwards and backwards, press the right or the left navigation key respectively.

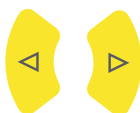

Starting / stopping the measurement

Press the Enter key in the measurement screen.



Left:
Zooming the measurement screen

Right:
Balancing runs in the measurement screen

Starting/stopping the measurement:
<Start> / <Pause>

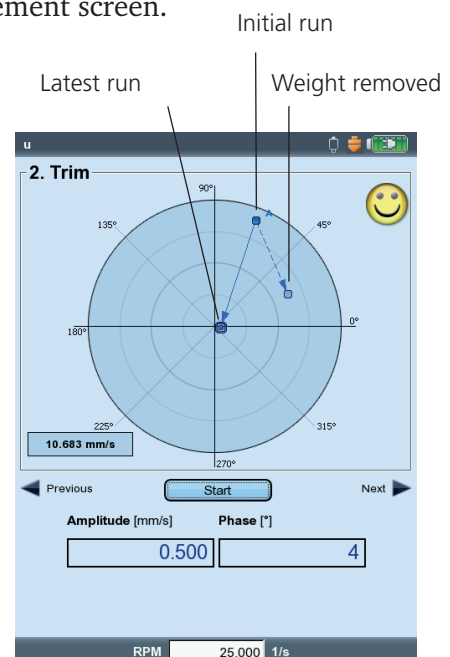
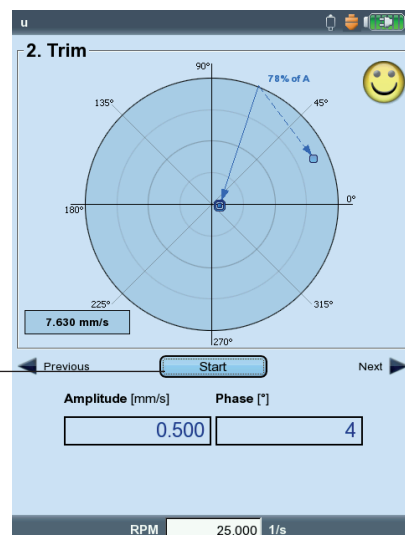

Balancing in one plane

On the basis of an example, the next section illustrates the steps that are needed to balance in one plane:

Requirements

- In the following example, the machine setup is not used.
- The default settings in the 'Tools' menu item are not changed:
 - Correction mode: free
 - "Add" balancing weights
 - Check that the functions are all active, except for the coefficients calculation which is inactive.
 - 'Use different radii' option: inactive

Activating the balancing mode

1. Switch on VIBXPERT.
2. Click on the "Balancing" icon in the start screen.



Selecting the task

1. Open the '1-plane' tab.
2. Highlight the rotor graphic which corresponds to the rotor type.
3. Optional: Check and change the current measurement task beforehand if necessary. (MENU - Task Manager - Setup)
4. Click on the rotor graphic to open the measurement screen



Adjusting the trigger sensor

1. Connect the trigger sensor to VIBXPERT (see p. 2-7).
2. Press MENU, and click on "Power up keyphasor".
3. Adjust the trigger sensor to the reference mark on the shaft.

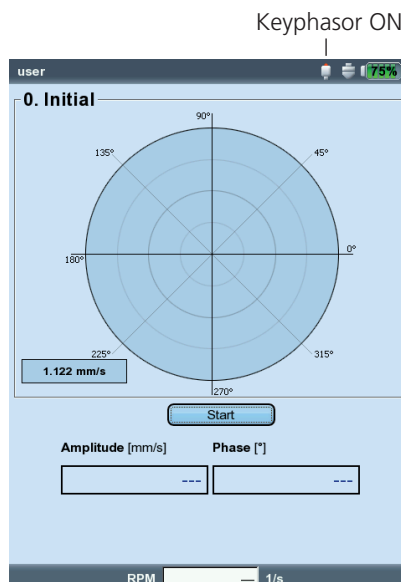
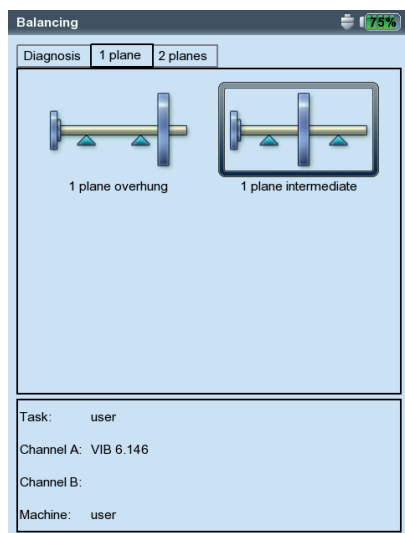

Left:
Selection screen

Right:
Start 'Initial' run

Measuring the initial imbalance

1. Switch the machine on. Wait until the machine has reached the balancing RPM and operating temperature if necessary.
2. Press 'Enter' to start the measurement.

Enter

First, VIBXPERT records the RPM. The green LED flashes with each trigger pulse. If the RPM varies too much, a warning message appears.

Finally, the instrument measures the amplitude and phase of the RPM synchronous vibration. If the values are unstable, the average is automatically increased.

Enter

3. If the measurement values are stable, press 'Enter' to stop the measurement (see previous page).
To repeat the measurement, press 'Enter' again.

4. Switch the machine off.

Trial run

1. Press the right navigation key to open the data screen for the trial run.
2. Enter the mass and fixing angle for the trial weight.
Click on the mass or angle field under the rotor graphic, and enter the respective value in the number editor.



If the trial mass is applied at random, there is a risk of increased imbalance and thus an increased vibration load. Especially if vibration loads are already very high, this may result in further machine damage.

3. Press the right navigation key until the next screen appears.

Left:
Measure 'Initial' run

Right:
Enter mass and angle for trial run

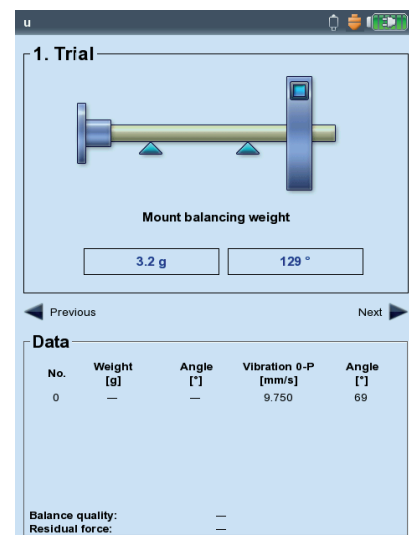
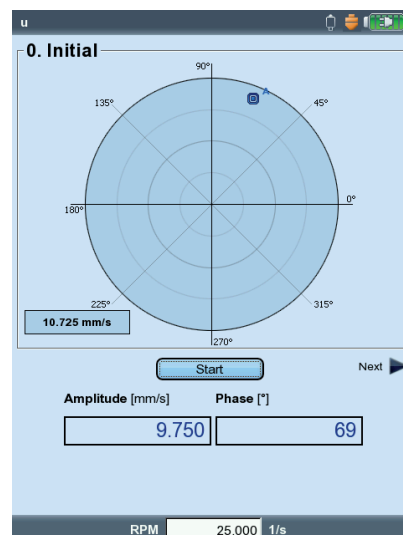

4. Switch the machine on.
5. Press 'Enter' to start the measurement.
6. If the measurement values are stable, press 'Enter' to stop the measurement.
7. Switch the machine off.

Enter

In the trial run the imbalance should change enough to steadily reduce the residual imbalance in the subsequent balancing runs. If the imbalance changes only slightly, increase the trial weight. If the imbalance has more than doubled, use a smaller trial weight (see the 'Tools' parameter, 'Check bad influence', p. 2-21). If necessary, scroll back in the data screen of the trial run, change the mass accordingly and repeat the trial run.

Trim run

1. Press the right navigation key to close the measurement screen of the trial run and to open the data screen of the first trim run. Depending on whether the trial weight resulted in an improvement or not, it can be left on the rotor or taken off. Respond to the resulting prompt in the screen accordingly.
2. Attach the recommended mass at the specified position on the rotor. If necessary, also change the values.
3. Press the right navigation key until the next measurement screen appears.
4. Switch the machine on.
5. Press 'Enter' to start the measurement.
6. If the measurement values are stable, press 'Enter' to stop the measurement.
7. Switch the machine off.

▶

▶

Enter

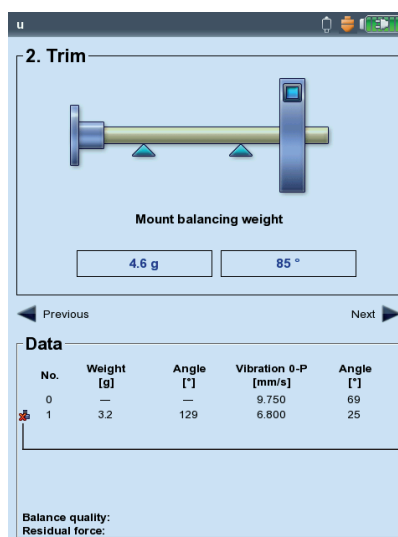
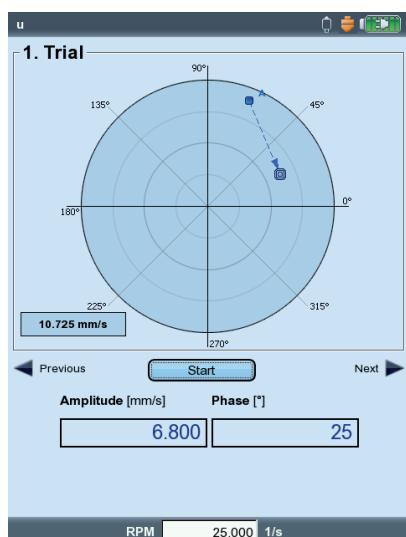

Left:
Measure trial run

Right:
Trim run data screen

 = Trial weight was removed

In the following trim runs VIBXPRT checks whether the imbalance has sufficiently reduced from one run to the next. If this is not the case, the following message appears: 'No Improvement'. The run concerned must be repeated with a different balancing weight.



Note

Start again if the vibration values worsen and the balancing weights do not become smaller.



8. Press the right navigation key and continue the balancing with the next trim run.



The balancing procedure is complete as soon as the vibration values have reached an acceptable value. When working with "Machine Setup", the calculated balancing quality is the criterion for terminating the balancing procedure. A 'smiley' appears in the measurement screen if the balancing quality has reached the tolerance range.

Undoing balancing runs

If the measurement results worsen after a trim run, you can return to a run that was acceptable and continue balancing with different weights from there.

- Navigate to the data screen of the trim run at which you wish to continue the procedure.
- Press the MENU button and click on 'Undo' (see below).
- Confirm the next query with 'Yes!'. All subsequent trim runs are deleted.
- Remove the balancing weights that you attached during the deleted trim runs.

Left:
Balancing quality achieved
(balancing with machine setup)

Right:
Undoing balancing runs

3. Trim

Mount balancing weight

0.2 g 20 °

No.	Weight [g]	Angle [°]	Vibration 0-P [mm/s]	Angle [°]
0	—	—	9.750	69
1	3.2	129	6.800	25
2	4.6	85	0.500	4

Balance quality: 0.153 @ 11.000 1/s
Residual force: 0.437 N @ 11.000 1/s

2. Trim

Mount balancing weight

85 °

No.	Weight [g]	Angle [°]	Vibration 0-P [mm/s]	Angle [°]
0	—	—	9.750	69
1	3.2	129	6.800	25
2	4.6	85	0.500	4
3	0.2	20	2.700	12
4	0.2	20	11.000	11

Balance quality: 0.153 @ 11.000 1/s
Residual force: 8.520 N @ 11.000 1/s

Balancing in two planes

In principle, the process here corresponds to the previous section. Therefore, only the specific features of balancing in two planes are described in the following section:

Overview of the measurement procedure

Select plane A: Determine the measurement and balancing plane A.

0. Initial imbalance: Measurement in plane A and plane B
- 1A. Trial run: Recommendation for trial weight in plane A; measurement in plane A and plane B with trial weight in plane A
- 1B. Trial run: Recommendation for trial weight in plane B; measurement in plane A and plane B with trial weight in plane B
2. Trim run: Recommendation for balancing weight in plane A & B; measurement in plane A and plane B
-
- N. Trim run ...

Determining the measurement plane & balancing plane A

1. Activate the balancing mode.
2. Open the "2 planes" tab.
3. Click on the rotor graphic which corresponds to the rotor type.
4. Select plane A:
 - Connect the transducer which is mounted in measurement plane A to measurement channel A (see "Overview").

Measuring the initial imbalance in plane A and plane B

Switch the machine on and start the initial run.

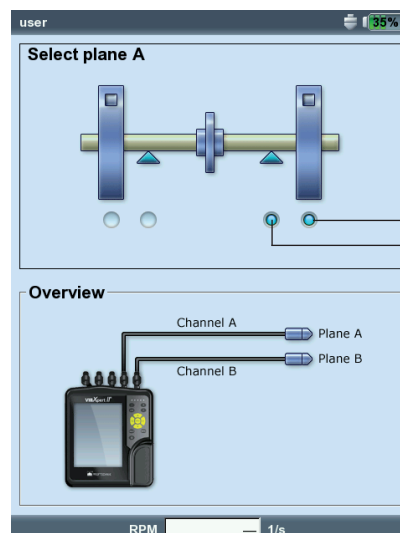
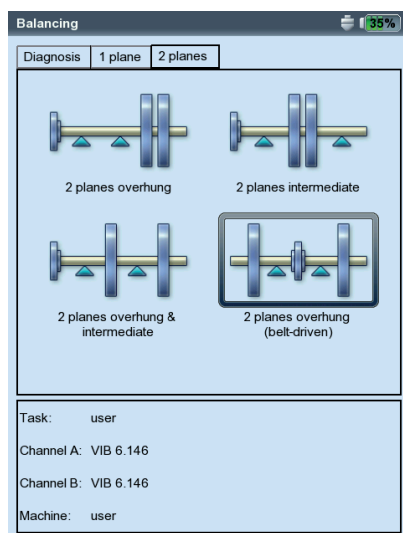

Left:
Selection screen - rotor type

Right:
Setting of plane A

Balancing plane A
Measurement plane A

Trial run

The trial run is divided into two parts which are marked in the main screen as "1A" or "1B":

1A: The trial weight is attached in **plane A** and its influence is measured in both planes.

1B: The trial weight is attached in **plane B** and its influence measured in both planes.

Trim run



Enter the balancing weights for both planes in the data screen of the trim run (see next page). Press the right navigation key to mark the input fields of the series.

Continue the trim run until the residual imbalance is within the tolerance range.

Saving the result

1. Press the MENU button in the data screen.
2. Click on 'Save' to open the text editor.
3. Enter a name.
4. Finally press the MENU button and click on 'OK'.

Current balancing plane is marked: blue (A) or green (B)

Left:
Input of trial weight in plane B

Right:
Trial run 1B
Imbalance in planes A and B with trial weight in plane B

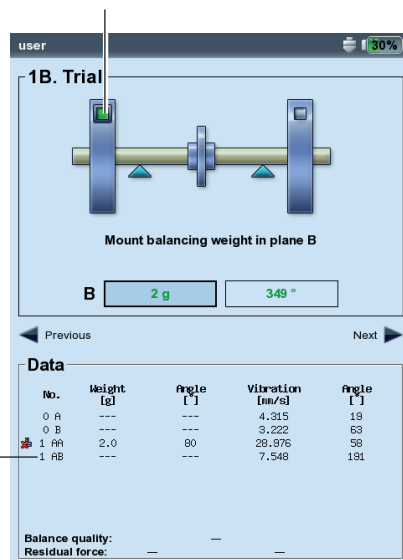

'AA': Result in **plane A**
'AB': Result in **plane B**
(trial weight always in plane A)

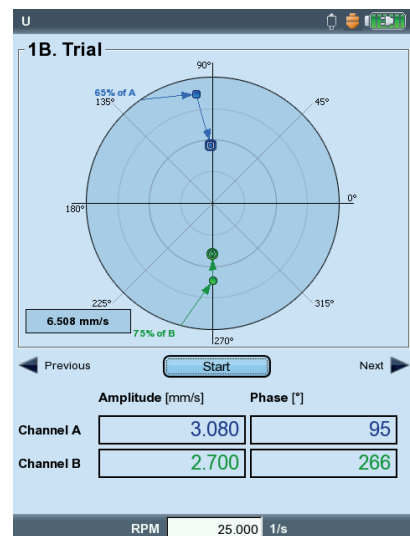

Evaluation of the data

The following data are listed in the data screen for each completed balancing run:

- MASS: Mass of the balancing weight
- ANGLE: Fixing angle
- VIBRATION: Vibration overall values (RMS, 0-p, p-p*)
- ANGLE: Phase angle

* see Display setup, p. 2-24

If you entered the rotor mass and the balancing radius in the machine setup or the tools menu respectively, then the achieved balancing quality and the centrifugal force on the rotor are also calculated. As a reference RPM, either the measured RPM or the explicitly entered RPM value is used (parameter, Speed (for balance quality), p. 2-22).

If the balancing quality is within the range of tolerance, the "smiley" appears and indicates the end of the balancing procedure.

Data View

- Press the MENU button in the data screen and click on "Data". The "Data View" screen appears.

Here you can combine several balancing weights to a single weight and display the following information:

- MACHINE NAME: Name of the machine setup if used
- DATE & TIME: Date and time of the last balancing run
- SPEED: Current rotational speed
- BALANCE QUALITY: Balance quality relative to reference speed.**
- RESIDUAL UNBALANCE: Imbalance after the last balancing run

** can differ from measured value.

An icon marks the balancing runs in the list where the attached balancing weight was removed again from the rotor after the measurement (e.g. trial run with weight in plane B: ('1BB'), see figure below). The corresponding vector is represented by a dashed line in the polar diagram (see illustration on page 2-10).

 = Balancing weight was removed

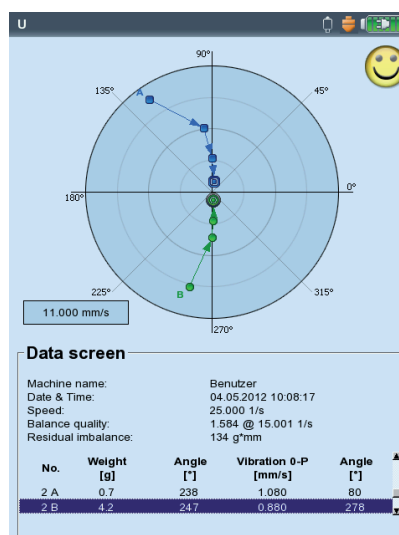
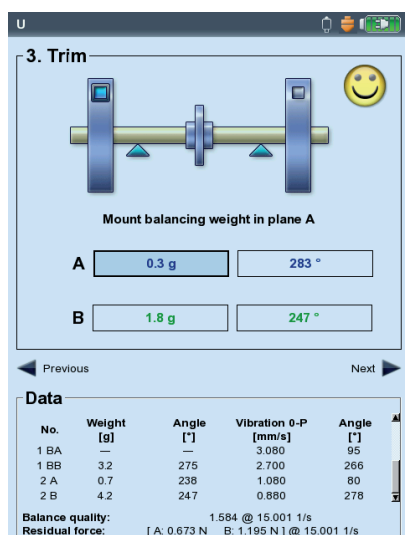

Left:
Data screen
Balancing quality OK

Right:
Data View screen

Options for balancing

1. Combining balancing weights

If several weights have already been placed on the rotor, they can be combined into one single weight. VIBXPERT vectorially adds the weights of the completed balancing runs and displays the resulting weight and fixing angle in the 'Data' screen and the 'Data View' screen.

- Press the MENU button in the Data screen, and click on 'Data'. The Data View screen appears.
- Press the MENU button, and click on "Combine":
The newly calculated balancing weight appears in the list in the line for the next balancing run. All combined runs are marked with a sum symbol ('Σ').
- Then press the MENU button and click on "OK" to accept the combination of the balancing weights.
- Before continuing with the next balancing run, remove the weights that were already attached and attach the newly calculated balancing weight to the rotor.

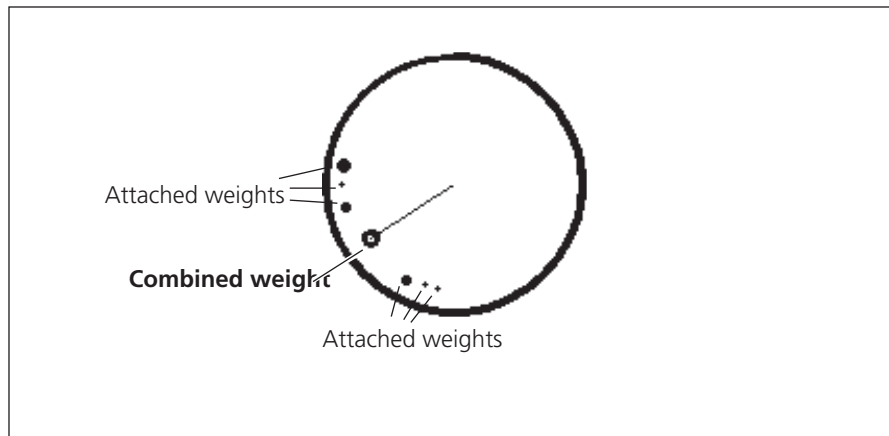

Combined weights

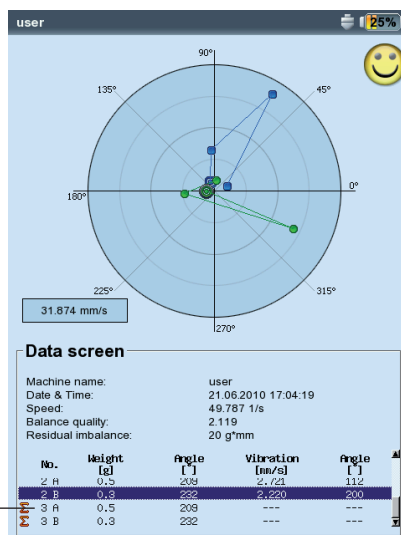

'A': Result in plane A
'B': Result in plane B

The weights from runs '1' to '2' were combined:
Run '3' is carried out with the newly calculated weight .

2. Changing the correction mode (Tools menu / Machine setup)

The correction mode describes how the balancing weight is attached to the rotor. Normally the correction mode is set to 'Free & add', i.e. the weight can have any mass and be placed at any angular position.

- Press the MENU button in the data screen, and click on "Tools" (see below)*.

The following correction modes are available additionally:

- Fixed location
- Fixed weight
- Measuring tape

The following can be selected for each correction mode:

- Add weight on rotor, or
- Remove weight from rotor

For 2-plane balancing the correction mode can be configured separately for each plane.

* Machine setup see page 2-26

2.1 Fixed location

To attach the balancing weight only at specific positions on the rotor (e.g. on the blade of a ventilator), select the "Fixed location" correction mode. Then enter the "Number of locations" on the rotor. VIBXPRT calculates two masses which are to be placed at two of the specified positions. Position or blade 1 corresponds to the 0° position and should be selected as a reference mark for the trigger. In the data screen, the angular position is displayed for each fixed location.

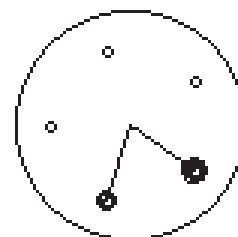

"Fixed location" correction mode

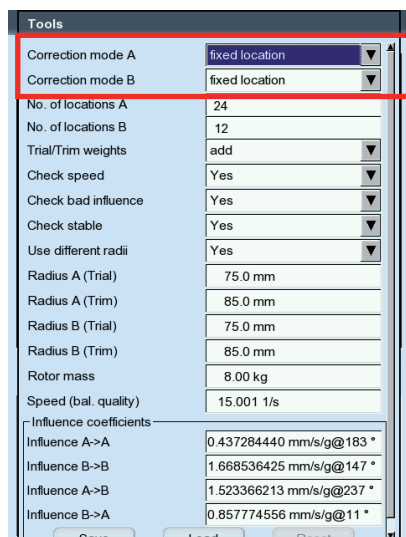
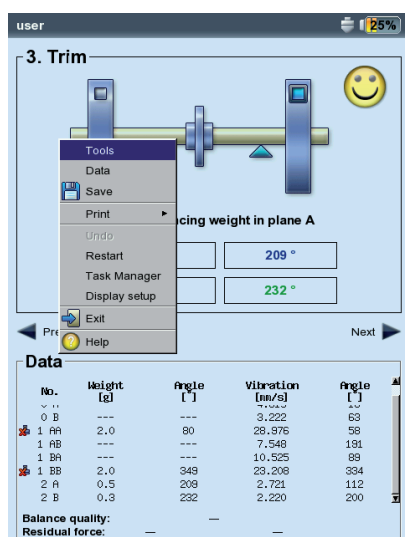

Left:
Changing correction mode in "Tools"

Right:
"Fixed location"
Setting the number of fixed locations

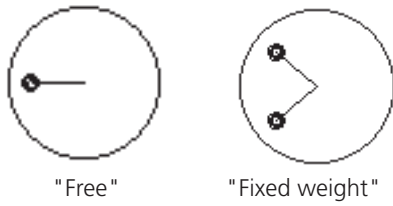

Note

2.2 Fixed weight

Activate the "Fixed weight" option if only specific masses (e.g. 2g, 5g, 10g) are available for balancing. Then enter the mass of the "Fixed weight". VIBXPERT calculates two angular positions at which the two equal weights must be placed.

Select the "Trial/ Trim masses -> Add" option in the "Tools" menu.

The fixed weight m_{fix} must meet the following requirements relative to the variable weight m_{free} :

$$0.5 \times m_{free} \leq m_{fix} \leq 3 \times m_{free}$$

2.3 Measuring tape

The correction mode can determine the position of the balancing weights with the measuring tape without having to consider a reference system with angular divisions.

Enter the outer diameter of the rotor in plane A and plane B. The distance on the outer surface of the rotor is calculated in millimeters (or inches) from the trigger mark (0° position) and measured counter to the direction of rotation. Place a tape measure around the rotor and place the balancing weight at the specified position (i.e. length).

The distance of the balancing weight from the rotational axis is the balancing radius. This is usually smaller than the outer radius.

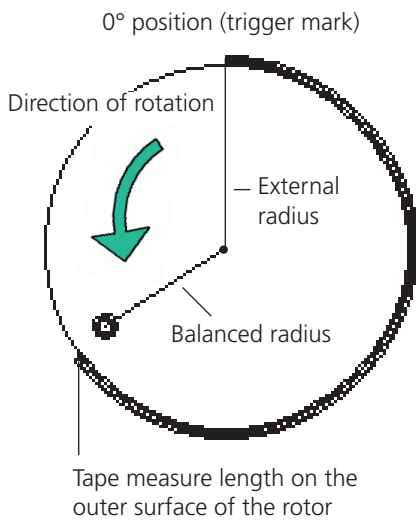

Note

In all three correction modes, the calculated specified values can be changed afterwards. However, the changes should not deviate significantly from the specified values.

The list in the "Data" field always shows the balancing weights for the 'Free' correction mode - i.e. mass and angular position.

Left:
"Fixed weight" correction mode

Right:
"Meas. tape" correction mode

No.	Weight [g]	Angle [°]	Vibration [mm/s]	Angle [°]
0 B	---	---	3,222	63
1 AB	2.0	80	28,976	58
1 AB	---	---	7,548	191
1 BH	---	---	10,526	89
1 BB	2.0	349	23,208	334
2 A	0.5	209	2,721	112
2 B	0.3	232	2,220	200

Balance quality: 2.119
Residual force: A: 1.989 N B: 1.424 N

No.	Weight [g]	Angle [°]	Vibration [mm/s]	Angle [°]
0 B	---	---	3,222	63
1 AB	2.0	80	28,976	58
1 AB	---	---	7,548	191
1 BH	---	---	10,526	89
1 BB	2.0	349	23,208	334
2 A	0.5	209	2,721	112
2 B	0.3	232	2,220	200

Balance quality: 2.119
Residual force: A: 1.989 N B: 1.424 N

3. Removing the balancing weight (Tools menu/ Machine setup)

If the balancing weights cannot be attached to the rotor by clamping, welding, screwing or similar, the imbalance can also be compensated by grinding material off the rotor. To do this, select the "Trial/ Trim weights -> remove" option in "Tools" menu (see below). VIBXPERT then calculates the "Balancing weights" with negative sign.

4. Check functions (Tools menu / Machine setup)

In order to ensure that the balancing procedure provides reliable and usable results, VIBXPERT has the following check functions:

- Press the MENU button in the data screen, and click on "Tools" (see below)*.

* Machine setup see page 2-26

CHECK SPEED

During measurement and between the balancing runs VIBXPERT checks whether the RPM is stable. An appropriate error message appears if the RPM varies excessively.

CHECK BAD INFLUENCE

The change of the imbalance indicator is checked between the balancing runs; if the change is too large or too small, an appropriate message appears. Return to the previous balancing run and reduce or increase the weight used.

CHECK STABILITY

The stability of the imbalance indicator is checked during the measurement. If the imbalance indicator is unstable and the 'Auto-average' option is active (s. p. 2-28), VIBXPERT automatically increases the selected number of averages in the measurement setup. An appropriate message appears if the maximum number of averages is reached.

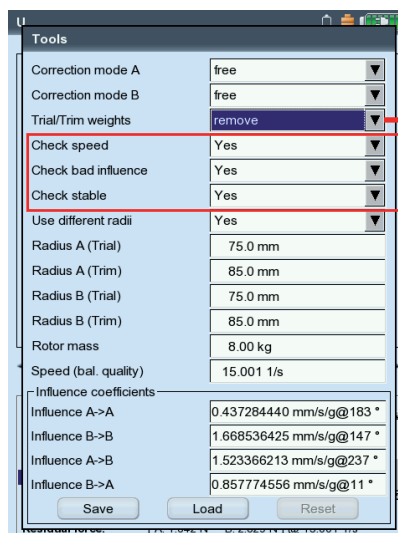

"Remove balancing weight"
Grinding off rotor material

Checking functions

5. Entering the balancing radius and rotor mass later (Tools)

If you start the balancing procedure without the machine setup, you can enter the balancing radius and the rotor mass later in the Tools menu. VIBXPRT then calculates the balancing quality and the centrifugal force for the current trim run.

If you use different balancing radii for the trial run and the trim runs, activate the 'Use different radii' option and enter the appropriate values.

6. Speed for balance quality (Tools menu / Machine setup)

The balance quality and the centrifugal force on the rotor are specified in relation to a reference RPM. In the Tools menu* you can enter a value under 'Speed for balance quality', which is used in all balancing runs. If you set this value to zero (= 'not used'), then the measured RPM is used for the calculation.

* Machine setup see page 2-26

7. Influence coefficient (Tools menu)

After the test run, VIBXPRT calculates the influence coefficient that is used to calculate the balancing weights in the subsequent balancing runs.

If you wish to use the influence coefficient from a previous balancing measurement, you have the following options:

1. Manual entry via the number editor:
 - In the Tools menu, click on 'Influence'.
 - First enter the amplitude.
 - Press the MENU button and click on 'OK'.
 - Enter the angle.

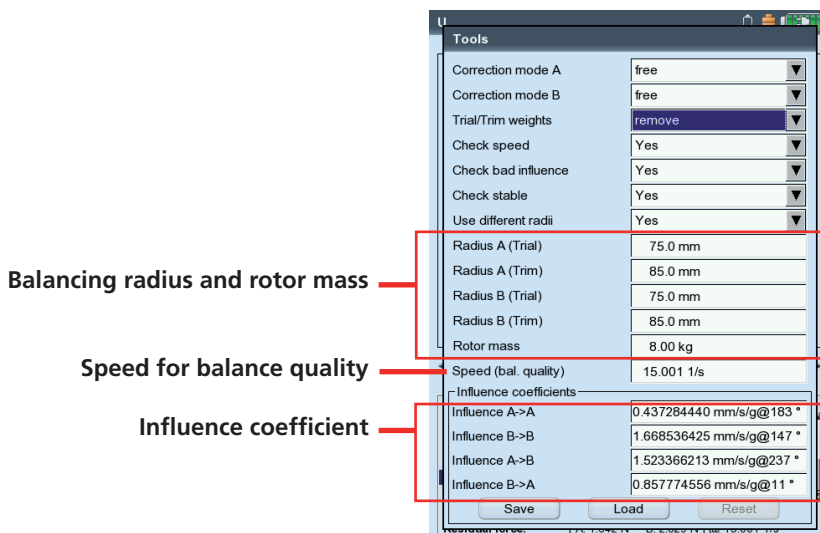

2. Load the coefficient from the file:

- Click on 'Load'.
- Select the coefficient file.

Here, the coefficient must be saved after the trial run.



Note

3. Adopting the influence coefficient by restarting from a file:

- Open the balancing file.
- Navigate to the last balancing step (measurement or data screen).
- Press the MENU button, and click on 'Restart'.
A warning appears. Click on 'OK'.
- Start the balancing measurement ('Initial imbalance').

To reset the influence coefficients in a file, click on 'Reset' in the Tools menu. To save the influence coefficients in a file, click on 'Save' in the Tools menu.

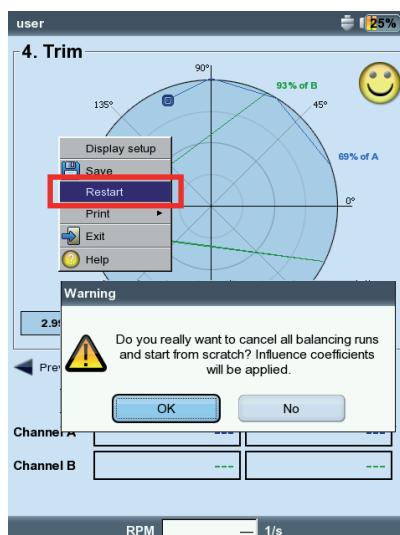

Adopting the influence coefficient by restarting

Display setup

In the display setup, you can define the display settings for the data screen and measurement screen. The display setup can be called up on every screen:

- Press the MENU button and click on 'Display setup'.

ZOOM: Speed or step size when zooming.

DUAL PLANE BALANCING, PLOT MODE: The imbalance pointers of the two planes can be displayed separately in *two polar plots* or together in *one polar plot*.

AMPLITUDE: The vibration amplitude can be specified in RMS, 0-p or p-p.

STEP LIST DETAIL: Select 'detailed' if you would like all balancing runs to appear in the data and measurement screen. The 'short' option only shows the first run (initial imbalance) and the last completed balancing run.

Left:
Opening the display setup

Right:
Parameter in the display setup

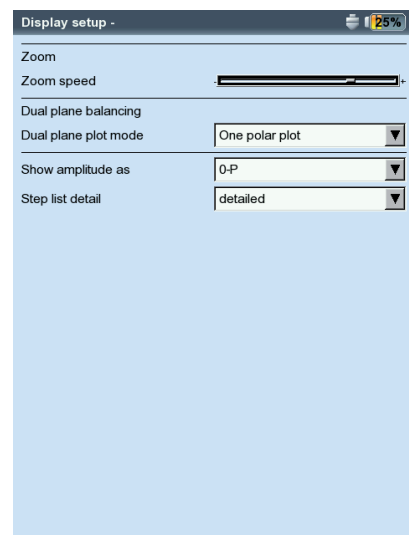
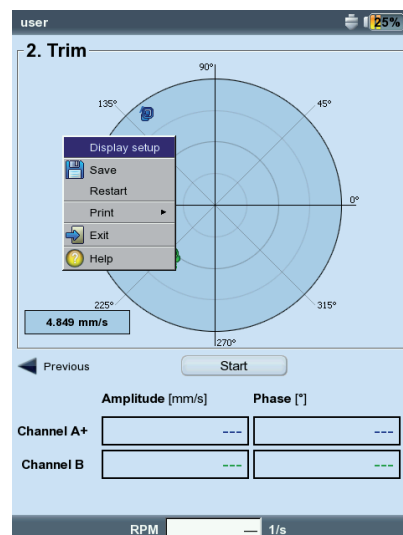

Printing the balancing report

Two different report types are available for documentation:

- *Screenshot*: Printout of the current screen
- *Report printouts*: Detailed report printout with general measurement data and balancing-related data.

A report printout can be started from the measurement or data screen:

Screenshot

- Press the MENU button and click on 'Print > Screenshot'.
- Select the printer, press the MENU button and click on 'Print'.

Report printouts

- Press the MENU button and click on 'Print > 'Report printouts'.
- Select the printer.
- Select the report configuration in the 'Reports' menu, or create a new report configuration (see VIBXPERT II manual, page 4-21).

General report information can be entered in the 'Common settings' tab.

The balancing-related report content is found on the 'Measure Info' tab:

POLAR PLOT: The balancing report contains a polar plot showing the completed balancing steps.

STEP LIST DETAIL: The balancing report contains all balancing steps ('detailed') or only the first and last steps ('short').

BALANCE QUALITY / IMPROVEMENT: The balancing report contains the balance quality (setpoint and actual value) if balancing was performed with the machine setup. If a machine setup was not used, the improvement in the vibration values is shown in percent.

- Press the MENU button and click on 'Print'.

Starting a report printout

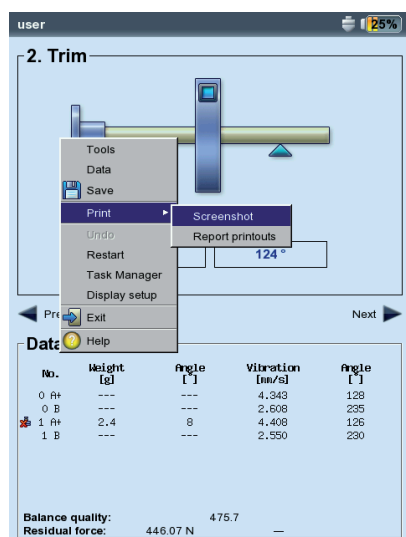

Balancing-related report content

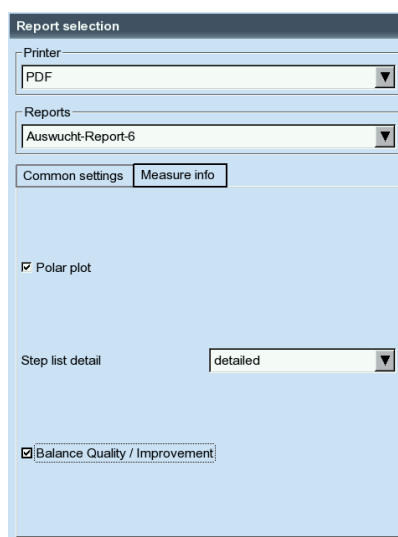

Balancing report

Prüftechnik Condition Monitoring GmbH		PRUFTECHNIK			
Dateiname: Ustbau					
Gedruckt am: 25.11.2008 08:22:14					
Gehessen am: 25.11.2008 07:53:43					
Messaufgabe: user MessSetup: user balancing					
Aufnehmer Setup: VIB 6.146					
Polar-Diagramm					
Auswuchtschritte					
Nr.	Masse [g]	Winkel [°]	Schwing. [mm/s]	Winkel [°]	Drehzahl [1/s]
0	---	---	2.746	196	49.052
1	1.0	9	3.935	249	46.545
2	1.2	137	2.075	300	46.545
3	0.7	208	---	---	---
Maschinen Info					
Maschinen Name: user					
Maschinen Drehzahl: 45.000 1/s					
SOUL-Auswuchtgröße: 2.50					
IST Auswuchtgröße: 4.065					
© 2008 PRUFTECHNIK AG V2.200505 1/1					

Setup parameters

To execute the balancing procedure VIBXPRT requires different settings, which are collected in 'setup menus':

- Machine setup (see below)
- Measurement setup (see p. 2-28)
- Transducer setup (see VIBXPRT II operating manual, page 2-20)

These setups are configured prior to a balancing procedure. During balancing, only certain parameters from the machine setup can be changed. These parameters can be found in the Tools menu (p. 2-19f.).

Machine setup

A 'machine setup' contains the machine data required for balancing. VIBXPRT uses these data to calculate a suitable trial weight and the residual imbalance, the centrifugal force and the attained balancing quality. In order to edit or create a machine setup, proceed as follows:

- Mark a rotor type in the selection screen (see p. 2-11).
- Press the MENU button and click on "Task manager".
- Select a user-defined task.
- Mark the "Machine setup" field.
- Press the MENU button and click on "New" or on "Edit":

The following parameters can be set:

PLANES: *One / Two*. Number of balancing planes; cannot be changed because the rotor type is selected in the selection screen.

CORRECTION MODE*: *Free / fixed location / fixed weight / meas. tape*; takes into account restrictions on the machine (fixed locations, e.g. for ventilator blades) or local circumstances (tape measure).

*This parameter can be changed in each balancing run (MENU - Tools)

Parameters in the machine setup

The screenshot shows the 'Setup Manager: Machine' dialog box. The title bar reads 'Setup Manager: Machine'. The main area is titled 'Machine setup' and contains a list of parameters with their current values or settings:

Parameter	Value
user	user
Planes	2
Correction mode A	fixed location
Correction mode B	meas tape
No. of locationsA	24
Outer diameter B	150.0 mm
Trial/Trim weights	add
Balance quality	2.5
Use different radii	Yes
Radius A (Trial)	75.0 mm
Radius B (Trial)	85.0 mm
Radius A (Trim)	75.0 mm
Radius B (Trim)	85.0 mm
Rotor mass	8.00 kg
Auto trial weight	Yes
Trigger angle A	90 °
Trigger angle B	90 °

Depending on the selection, the following parameters can be set:

- No. of locations: 3-100. Usually the number of ventilator blades.
- Fixed weight: Mass of the available balancing weight.
- Outer diameter: The tape measure can be used to determine the position of the balancing weight without a reference angle (see graphic on page 2-20).

When balancing in two planes the correction mode can be set separately for each plane.

TRIAL/TRIM WEIGHTS*: *add / remove*; in general, an imbalance is corrected by affixing weights to the rotor. If this is not possible, VIBXPERT calculates how much mass must be ground off the rotor ('negative').

BALANCE QUALITY: 0 - 4000; evaluation of the residual imbalance using quality grades according to DIN ISO 1940 (see p. 3-1). If the calculated balancing quality is smaller than the selected value, the 'smiley' symbol appears in the data screen and the balancing run is complete. Select the value "0" to work without evaluation of the residual imbalance.

The measured shaft RPM is used by default as the reference RPM for the calculation of the balance quality achieved. With the parameter 'Speed for balance quality' (see next page) you can execute the calculation of the residual imbalance in relation to an arbitrary RPM.

USE DIFFERENT RADII: *Yes / No*; the trial weights can be attached at a different radius than the balancing weights.

RADIUS: *Balancing radius*; distance of the balancing weight from the rotational axis; the larger the balancing radius, the smaller the balancing weight for the same RPM.

ROTOR MASS: The mass of the rotor is taken into consideration in the calculation of the trial weight.

AUTO TRIAL WEIGHT: *Yes / No*; VIBXPERT calculates a trial weight according to ISO 1940 and based on the balance quality, the rotor mass, the rotational speed and the balancing radius.

* This parameter can be changed in each balancing run (MENU - Tools)

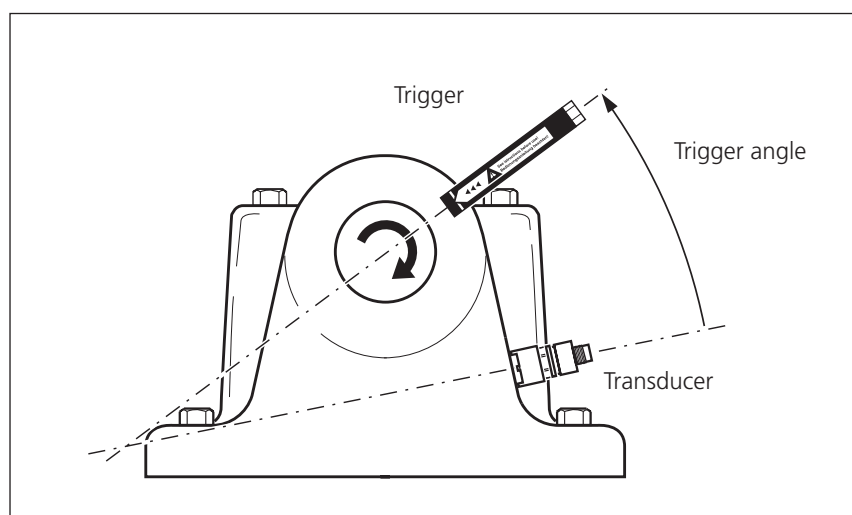

Trigger angle:

Angle between transducer and trigger is calculated counter to the direction of rotation of the rotor

TRIGGER ANGLE: The angle between the sensor and the trigger sensor is taken into account in the calculation of the attachment angle for the trial weight. Convention: Angle is counted against the direction of rotation of the rotor.

SPEED FOR BALANCE QUALITY*: Reference RPM for calculation of the achieved balance grade and centrifugal force (see p.2-22).

* This parameter can be changed in each balancing run (MENU - Tools)

CHECK SPEED*: Yes / No; see "Check functions" on page 2-21.

CONTROL 2ND PLANE: Yes / No; when balancing in one plane, the vibration in a second plane can be recorded and displayed as well (see also page 2-30).

MINIMIZE ERROR IN 2ND PLANE*: Yes / No; generally, the vibration in the control plane increases. Activate this option to calculate the balancing weights in such a way that the vibration in both the balancing plane and the control plane are minimized.

AUTO AVERAGE: Yes / No; with a strongly varying imbalance pointer, VIBXPRT automatically increases the selected number of averages in the measurement setup. This option works only in combination with the 'Check stability' option.

CHECK STABILITY*: Yes / No; see "Check functions", p. 2-21.

CHECK BAD INFLUENCE*: Yes / No; see "Check functions", p. 2-21.

RECALCULATING COEFFICIENT

The coefficient for calculating the balancing weight can be taken over from the trial run (setting: "No") or from the previous balancing run (setting: "Yes"). Only available for 1-plane balancing.

FREE-RUN: Yes / No; the free-run mode abbreviates the balancing procedure. In this mode, only the measurement screen appears. The weight and the position of the balancing weights is not displayed. In the machine setup, all options that are used to calculate the balancing weights are deactivated. This mode should only be used by balancing experts.

Parameters in the machine setup

Left:
Machine setup for
2-plane balancing

Right:
Machine setup for
1-plane balancing

Machine setup	
user	user
Balance quality	2.5
Use different radii	Yes
Radius A (Trial)	75.0 mm
Radius B (Trial)	85.0 mm
Radius A (Trim)	75.0 mm
Radius B (Trim)	85.0 mm
Rotor mass	8.00 kg
Auto trial weight	Yes
Trigger angle A	90 °
Trigger angle B	90 °
Speed (bal. quality)	15.001 1/s
Check speed	Yes
Auto average	Yes
Check stable	Yes
Check bad influence	Yes
Free-run	No

Machine setup	
user	user
Trial/Trim weights	add
Balance quality	2.5
Use different radii	No
Radius A	75.0 mm
Rotor mass	8.00 kg
Auto trial weight	No
Trigger angle A	90 °
Speed (bal. quality)	Disabled
Check speed	Yes
Control 2nd plane	Yes
Min. error in 2nd plane	Yes
Auto average	Yes
Check stable	Yes
Check bad influence	Yes
Recalc coefficient	No
Free-run	No

Measurement setup

In order to edit or create a measurement setup proceed as follows:

- Mark a rotor type in the selection screen (see p. 2-11).
- Press the MENU button and click on "Task manager".
- Select a user-defined task.
- Mark the "Measurement setup" field.
- Press the MENU button and click on "New" or on "Edit":

The following parameters can be edited:

FILTER: *0.5 / 1 / 2 / 10 Hz*; select "10 Hz" as the lowest frequency if the machine RPM is more than 600 RPM and the machine is placed on a soft foundation.

LOWPASS FILTER: *Yes / No*; To suppress high frequency noise signals, a low pass filter (1 kHz) can be activated (Yes). With 'No', the signal is processed without the low pass filter.

NO. OF MEASUREMENTS: *1 - 20*; the number of measurements is automatically increased to the maximum value if the indicator shows strongly varying imbalance.

TIME SYNCHRONOUS AVERAGING: In this type of averaging, the time signals of each individual rotation are averaged to reduce non-synchronous components in the signal. The calculated phase values are likewise averaged to increase the stability of the phase vector. The parameters for the phase averaging correspond to the settings under "No of measurements" (see above). The number of time synchronous averages is either RPM-dependent, user-defined or infinite:

‘Auto’: Time synchronous number of averages is rpm-dependent.

‘Manual’: Time synchronous number of averages can be entered (max. 254).

‘Infinite’: Each individual measurement is averaged with the preceding individual measurement. The longer the measurement takes, the more stable the final result. This average type is generally used for balancing. The measurement must be stopped using the Enter key.

MEASUREMENT RANGE: The measurement range for the analog channel (A/B) can be automatically matched to the input signal ('Auto') or set to fixed. When set to '[Value] / Auto-Up', the measurement range is automatically increased when the upper limit is exceeded.

Measurement setup	
user balancing	
Meas. quantity	Velocity
Lower frequency	10.00 Hz
Lowpass filter	No
No. of measurements	5
Timesync. averages	Infinite
Measurement range	Auto

Parameters in the measurement setup

Balancing with a control plane

While balancing in one plane, the vibration pointer in a second plane - the control plane - can be recorded and displayed as well.

Activating the control plane

In the machine setup activate the 'Control 2nd plane' option (see p. 2-28 below).

Connect the transducers to the measurement channels

Connect the transducer in the *balancing plane* to the channel that is selected in the measurement task manager. Connect the transducer in the *control plane* to the other channel.

Display

In the measurement and data screen, the balancing plane is marked with a plus sign (+) (plane A in the example below).

Reducing vibration in the balancing and control planes

Vibration in the control plane generally increases with each balancing run since VIBXPRT calculates the balancing weights for the balancing plane. To reduce the vibrations in both planes as far as possible, you can include the measurement values from the control plane in the calculation of the balancing weights.

Activate 'Minimize 2nd plane error' - either in the machine setup before beginning the balancing procedure (see p. 2-28), or during balancing in the 'Tools' menu (see below).

Left:
Single plane balancing
with control plane

Right:
Minimizing the vibration in the
control plane

Balancing plane is indicated by a '+'
Control plane

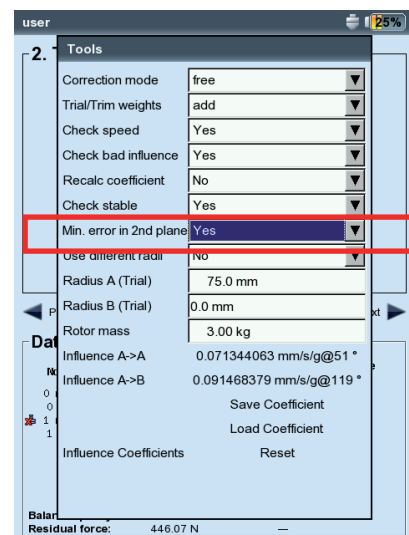
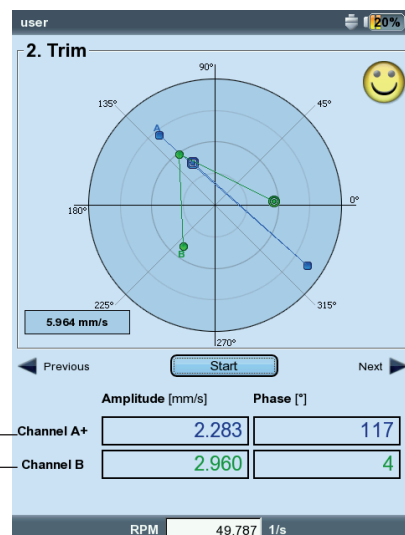

Balance calculator

With the VIBXPRT balance calculator you can convert any arrangement of balance weights on a rotor to a resulting weight.

The balance calculator operates as an independent functional module. The result cannot be saved or used in an ongoing balancing procedure.



Note

For each weight on the rotor you can configure or enter the following parameters separately:

- Correction mode
- Weight
- Position
- Balancing radius

The correction mode can be selected for the resulting weight. If parameters are changed, the calculator automatically updates the result.

Remarks

The calculator uses the balancing radius from the current machine setup for calculating the resulting weight. For the correction modes 'Fixed weight' and 'Fixed location', the values from the current machine setup are also used by default. The weights can be changed in the calculator; the number of fixed locations can only be configured in the corresponding machine setup.

In case you start the balance calculator without an active machine setup, the calculator uses the corresponding values from the machine setup 'user'.

- Change the parameters in the corresponding machine setup, if necessary.

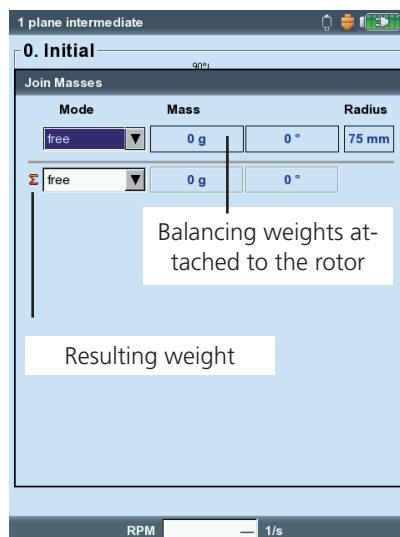
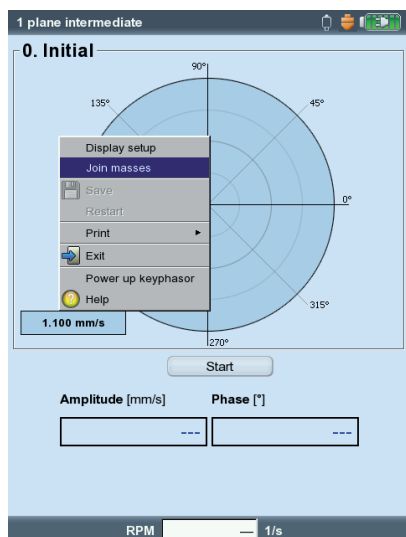

Left:
Select 'Join masses' to start
the balancing calculator

Right:
Balancing calculator

Operation of the balance calculator

The calculator can be started before or during a balancing procedure.

- Press MENU and click “.
- Press the Plus (+) key to add a new weight.



Note

In the correction modes ‘Fixed location’ and ‘Fixed weight’, two weights are possible for each line.

- Press the Minus (-) key to delete the marked weight from the list.
- Configure the required parameters for each weight in the list. Use the navigation keys to navigate within the list.
- You can select the correction mode for the resulting weight in the last line.



Note

If the resulting weight cannot be calculated in the configured correction mode, a corresponding message will be displayed. The result is then displayed for the ‘free’ mode.

* e.g. because the fixed weight in the machine setup is too small.

Left:
Result for measuring tape
correction mode

Right:
Result for fixed weight
correction mode

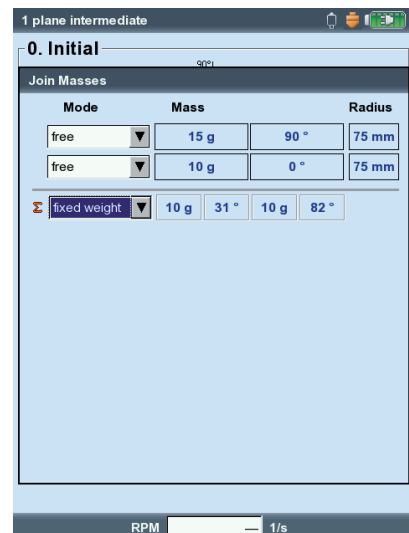
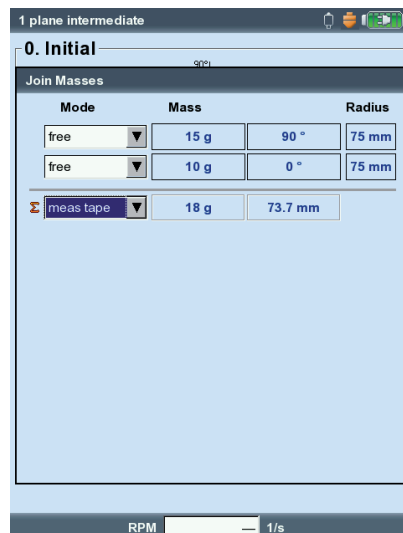

Chapter 3: Appendix

This section contains the following information:

- Overview of the quality classes according to DIN ISO 1940. This enables the user to set up the balancing quality in the machine setup.
- Messages that may appear during the balancing procedure.

Balancing quality classes and groups of rigid balancing bodies

(excerpt from DIN ISO 1940)

Qty. class	Examples of balancing bodies or machines
630	Crank gear rigidly assembled four-stroke engines and elastically mounted ships diesel engines
250	Crank gear rigidly mounted, high-speed 4-cylinder diesel engines
100	Crank gear rigidly mounted, high-speed diesel motors with six and more cylinders
40	Automobile wheels, rims, wheel sets, drive shaft crank gear elastically mounted, high-speed four-stroke engines with six and more cylinders
16	Crank gear components of automobile, truck and locomotive engines, crank gear of six and more cylinder engines with special requirements"
6.3	Fans, flywheels, centrifugal pumps, machine construction and machine tool construction parts
2.5	Impellers of jet power plants, gas and steam turbines, turbo blowers and generators
1	Tape recorder and phono drives, grinding machine drives
0.4	Precision grinding machine anchorages, shafts and disks, gyroscopes

Messages during balancing

Insufficient improvement

The vibration values are greater than 1 mm/s and have not sufficiently improved. Check whether the cause is actually an imbalance.

One-plane balancing is recommended

The dynamic portion of the calculated imbalance is larger than the static portion. The results will not be significantly improved if you proceed to balance in two planes.

Remove balancing weight?

You can leave the balancing weight on the rotor or remove it after each balancing run. Answer the question with YES or NO.

RPM measurement

VIBXPERT measures the RPM before each balancing run. The green LED lights up if the RPM sensor sends a pulse.

Please check trigger sensor!

There is no signal from the trigger / RPM sensor. Possible causes: signal path is interrupted, poor light conditions, incorrect orientation of the trigger optics for the reference mark, ...

Initializing

The measurement amplifier is adjusted (Autorange)

Speed fluctuates. Results can be influenced!

The RPM variation is too large or deviates too much from the measured RPM of the preceding balancing run. Wait until the machine has reached the balancing RPM before starting the measurement.

Vibration pointer unstable

The magnitude and/or the phase of the vibration pointer is changing too much. VIBXPERT automatically increases the selected number of averages until the signal is stable or the maximum number of averages (20) is reached.

Maximum number of averages reached

VIBXPERT has set the number of averages to 20. If the vibration pointer has stabilized, the balancing runs can be continued.

Balancing planes cannot be separated (2-plane balancing)

The influences of the balancing weights in the other plane are the same or are adjusted so that they increase at the same time. Under these conditions, the results for the subsequent balancing runs cannot be used. Balancing in one plane is recommended.

Pointer change too large

The vibration pointer in the trial run has changed too much in magnitude and phase in comparison to the initial imbalance run.

Pointer change too small

The vibration pointer in the trial run has not changed enough in magnitude and phase in comparison to the initial imbalance run.

If the change is too large, the trial weight must be reduced. If it is too small, the trial weight must be increased.

Restart is recommended (1-plane balancing)

If the vibration values increase and the balancing weights increase from one balancing run to the next, no further improvement can be expected. The entire balance measurement must be restarted.

Masses combined.**Remove previously attached masses!**

The previously attached balancing weights are added together (vectorially) to form a single weight. Attach the weight calculated in the data screen to the rotor, and remove all previously attached balancing weights. Start the next balancing run. In comparison to the last run, the balanced state should not change substantially.

Emergency storage

If the balancing procedure is stopped prematurely (e.g. battery discharged), the data are stored in a recovery file. When the device is switched on again, the balancing procedure can be continued with the aid of this recovery file.

Opening the recovery file

- Switch on the measuring device.
- In the start screen, click on the 'Balance' symbol.
- Open the tab in which the interrupted balancing procedure was started (e.g. '1 plane').
The recovery file is labeled with a warning symbol.
- Click on the recovery file to open the recovery dialog box. It shows information on when the emergency storage took place and the number of balancing steps (see below).
- Click on 'Restore' to open the file and continue the balancing procedure, or to save the data properly.
Click on 'Discard' to clear the data in the recovery file and start a new measurement.
Use 'Exit' to leave the recovery dialog box without deleting the recovery file.



Continuing the balancing procedure after emergency storage

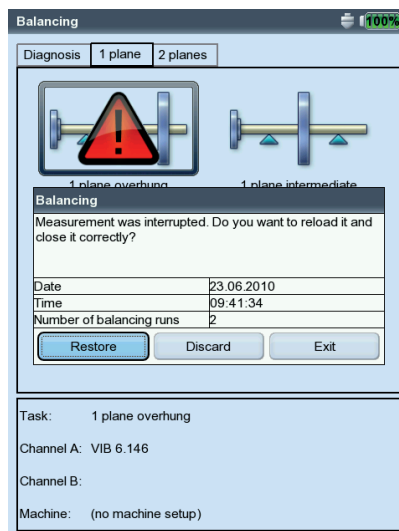

Index**A**

Assembly 2-5
Auto average 2-28
Auto trial weight 2-27

B

Balance calculator 2-31
Balance quality 2-27
Balancing in one plane 2-11
Balancing in two planes 2-15
Balancing radius 2-22
Balancing report 2-25

C

Check bad influence 2-21
Check speed 2-21
Check stability 2-21
Combining balancing weights 2-18
Control 2nd plane 2-28
Control plane 2-30
Correction mode 2-19, 2-26
Couple imbalance 2-1

D

Data View 2-17
Diagnosis 2-4
Display setup 2-24
Dynamic imbalance 2-1

E

Emergency storage 3-4

F

Filter 2-29
Fixed location 2-19
Fixed weight 2-20
Free-run 2-28

I

Imbalance 2-1
Influence coefficient 2-22
Initial imbalance 2-12
ISO 1940 3-1

J

Join masses 2-32

L

Laser trigger sensor 2-6
Lowpass filter 2-29

M

Machine setup 2-26
Measurement range 2-29
Measurement setup 2-29
Measuring tape 2-20
Minimize error in 2nd plane 2-28

N

No. of measurements 2-29

R

Radius 2-27
Recalculating coefficient 2-28
Registration 1-7
Removing the balancing weight 2-21
Report 2-25
Rotor mass 2-22, 2-27

S

Screenshot 2-25
Speed for balance quality 2-22, 2-28
Static imbalance 2-1

T

Time synchronous averaging 2-29
Trial run 2-12
Trial/Trim weights 2-27
Trigger angle 2-28
Trigger sensor 2-6
Trim run 2-13

U

Undoing balancing runs 2-14
Use different radii 2-27

Productive maintenance technology

Fluke Deutschland GmbH
Freisinger Str. 34
85737 Ismaning, Germany
+ 49 89 99616-0
www.pruftechnik.com

Printed in Germany LIT 53.202.12.2019.0G